

The leading motorsport technology publication since 1990

Racecar engineering™

Formula 1 2015 • Digital edition • www.racecar-engineering.com

Formula 1 2015

Full technical analysis of this season's grid



Peter Wright, Sam Collins,
Ricardo Divila, Simon McBeath
Nicolas Perrin, Andrew Cotton



TOYOTA MOTORSPORT GmbH

HIGH-PERFORMANCE TESTING FOR MOTORSPORT

AT TMG WE HAVE A TESTING SOLUTION FOR VIRTUALLY EVERY MOTORSPORT NEED. WHETHER IT IS FOR A FULL CAR OR SINGLE COMPONENT, WE BRING HIGH PERFORMANCE TO YOUR PROJECT



TMG brings the benefits of its World Championship-winning experience to clients throughout the global motorsport industry.

The 30,000m² facility in Cologne, Germany covers engine, chassis and component testing via virtual and real-world testing solutions, with highly-qualified, experienced engineers on hand to optimise every project.

From high-tech simulation and calculation techniques to a diverse range of R&D testing facilities, TMG can deliver performance and value to motorsport teams from different disciplines.

As an award-winning service supplier, TMG already provides bespoke solutions to motorsport teams at various levels as well as world-renowned automotive companies, including Toyota Motor Corporation.

Whether it is wind tunnel sessions with a model or full-size car, seven-post rig analysis or engine dyno testing, TMG is at the pinnacle of motorsport research and development.

Contact us to find out more!



The 2015 Formula 1 season may not go down as a classic in terms of the quality of the racing, but from an engineering and political perspective this season provided some wonderful stories. Mercedes' domination of the sport continued in 2015 and, from a technical point of view, what it achieved was mightily impressive. The other power unit suppliers have work to do, but under the powertrain token system there is only so much that they can do. This season, we majored our coverage on those power unit suppliers, looking at what they had achieved, as well as looking at the complete car design for each team.

While we analysed the current cars, we also took a view of the sport overall from a technical standpoint and offered opinions of leading

engineers with no affiliation to the teams, and therefore no agenda, as to what can be done to 'improve the show'. There are a number of options, but key is to identify what Formula 1 wants to be, and for that it also needs to work out who is in charge. Is it CVC, under which Bernie Ecclestone operates? Is it the manufacturers, whose money and commitment to Formula 1 is also critical to its success? And how powerful are the teams such as Manor, Williams, Force India and Sauber? They may not have the financial clout of the big teams, but then without them the show would suffer. Each faction has its own agenda at the negotiation table, and that is primarily where the problems lie. Formula 1 must either clarify its core identity, or find a solution where each of the parties around the table gets what it requires.

Paddock gossip was delightfully ripe this year. What happens after CVC sells its share in F1? What was Max Mosley doing mid-season on television with Bernie Ecclestone? What is the future for Lotus and Renault? What is the future of the Red Bull team? Will there, after all, be an option for a non-hybrid engine for the smaller teams? How close was Michelin to securing the exclusive tyre deal and what would it have meant? And, more recently, what is happening with the fuel flow meter, and how are Haas and Ferrari developing their 2016 cars? I would argue that this has been a fascinating season and I hope that in these pages you enjoy the very best of our 2015 coverage.

ANDREW COTTON
Editor, Racecar Engineering



Contents

<p>5 STRAIGHT TALK Ground effect anyone?</p> <p>7 PETER WRIGHT The value of unpredictability</p> <p>10 SAM COLLINS How teams adapt to new regs</p> <p>18 WRIGHT STUFF Figuring out power unit potential</p> <p>26 TECH UPDATE First look at 2015 power units</p>	<p>28 CRYSTAL BALL Can anyone stop Merc?</p> <p>30 MERCEDES Analysis of an incredible engine</p> <p>38 FERRARI The race to close the gap</p> <p>46 RENAULT Renault Energy F1-2015</p> <p>52 HONDA The first steps on a long road</p>	<p>58 F1 CFD 1 Simulation of a modern F1 car</p> <p>64 F1 CFD 2 Dynamic flow fields</p> <p>72 BACK INJURY STUDY The future of cockpit design uncovered</p> <p>78 PERRIN Low-cost, high value development</p> <p>84 THE FUTURE The next step for F1 power units</p>
---	---	---

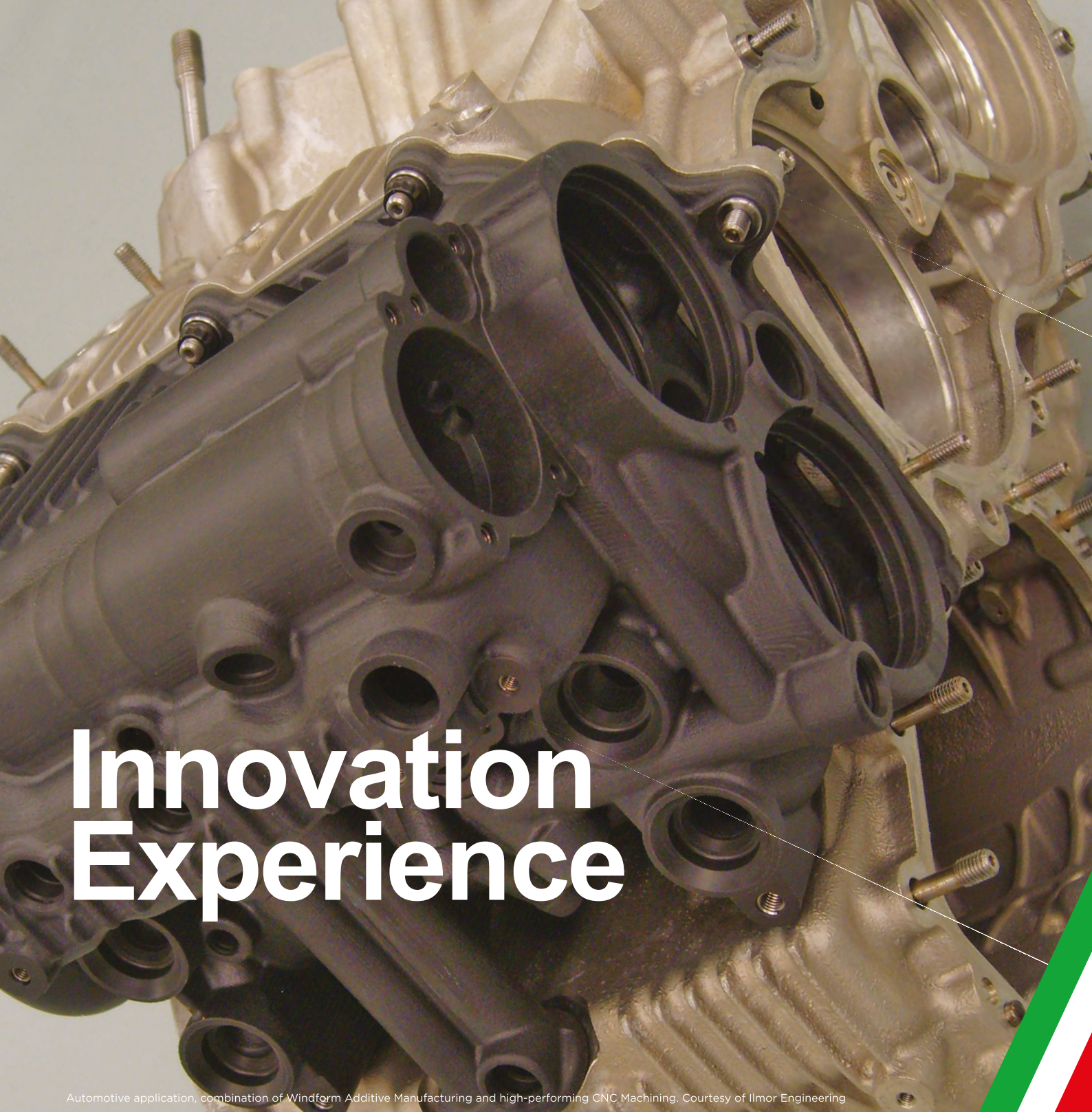

Innovation Experience

Automotive application, combination of Windform Additive Manufacturing and high-performing CNC Machining. Courtesy of Ilmor Engineering



CELEBRATING 45 YEARS OF PRODUCING EXCELLENCE

Our Italian craftsmanship and distinguished dedication to bringing your visions to life make us the choice partner in gaining technical advantages in high precision CNC Machining and 3D Printing that few others can guarantee.

Producing quality, reliability, innovative solutions and speedy delivery service for 45 years.



www.crp.eu

45 YEARS OF EXPERIENCE

info@crp.eu

HIGH PRECISION CNC MACHINING & WINDFORM ADDITIVE MANUFACTURING



Skirting the issue

F1's ground effect era was not without its problems, as our columnist remembers

Ground effects was the Pandora's box of motor racing, for the exploitation of depression under a racing car changed the paradigm of design forever. Despite all the King's horses and all the King's men, and all the regulations that the FIA and other sundry racing organisations have thrown at it, it embodies the cliché: once things have been seen, they cannot be unseen.

The Lotus 78 was the first ground effect car that really worked, and it was sealing the leak from the gap between bodywork and ground that was the *bingo* idea. The skirts used for this actually started as some brushes closing the gap between the sidepod and ground, massively increasing the depression caused by a nice application of Daniel Bernoulli's principle. Fluid dynamics states that for an inviscid flow an increase in the speed of the fluid occurs simultaneously with a decrease in pressure or a decrease in its potential energy.

Bernoulli's principle

It can be derived from the principle of conservation of energy. This states that, in a steady flow, the sum of all forms of energy in a fluid along a streamline is the same at all points on that streamline. This requires that the sum of kinetic energy, potential energy and internal energy remains constant.

Thus an increase in the speed of the fluid – implying an increase in both its dynamic pressure and kinetic energy – occurs with a simultaneous decrease in (the sum of) its static pressure, potential energy and internal energy. If the fluid is flowing out of a reservoir, the sum of all forms of energy is the same on all streamlines because in a reservoir the energy per unit volume is the same everywhere.

Bernoulli's principle can also be derived directly from Newton's Second law. If a small volume of fluid is flowing horizontally from a region of high pressure to a region of low pressure, then there is more pressure behind than in front. This gives a net force on the volume, accelerating it along the streamline.

The first iterations of ground effects had to climb the steep mountain of getting the CP (centre of pressure) in the right place and making sidepods strong enough to take the loads. It was all a rather hit-or-miss affair, with a whole new paradigm being hammered out race by race as the new ideas were explored. One example of the conundrums we were facing was the inversion of known facts. Putting more rear wing on to counter high speed oversteer could actually increase the oversteer, as the underwing suction from the rear wing would increase the depression at the trailing edge of the underwing and, if your CP was slightly forward,

would shift the aero balance even further forward. The eventual solution of suppressing front wings was one of the fixes if your CP was too far forwards, while drilling hole-saw cuts in the skirts to shift said CP backwards was another way.

The introduction of polypropylene skirts rubbing away at the ground evolved into different density sheets, flexi at the hinge-points, then stiffer near the ground. The next steps were more complex, and the introduction of sliding skirts morphed into quite complex spring-loaded slabs of honeycomb composites with ceramic skids to make them last longer than the easily worn poly skirts, plus the introduction of side rollers to keep stiction from jamming them in a leaky position, because the loads on skirts were rapidly increasing as the cars improved.

Many drivers did not like the cornering on rails behaviour this downforce gave, plus the fact that, counter-intuitively, the faster you went the car felt less on the edge, it being planted by the higher downforce provided by increased speed. It was

Putting more rear wing on to counter high speed oversteer could actually increase oversteer



Formula 1 embraced ground effect after the Lotus 79 dominated in 1978. It was then banned in 1983

also not too comforting to know that when that downforce was not there your intention of keeping it between the white lines was a forlorn hope.

It got to the point that some cars had rods mounted on the front end of the skirts, protruding through the bodywork to give drivers fair warning that his skirt was up, thus avoiding the embarrassment of coming off the road due to lack of grip. Yet ground effect also made the cars look easy to drive. So much for showmanship.

Another side effect of the downforce was the dreaded porpoising. This describes the effect

of vehicle dynamics, turbulent flow, near-sonic speeds at the venturi throat, all coupled with boundary layer detachment and suspension and tyre frequencies.

The sequence would go something like this: increased speed would compress the suspension and tyres, closing the venturi and accelerating the air passing underneath, which would increase the downforce, further closing the gap. Eventually the amount of downforce would be drastically reduced due to choking of the throat, it going sonic or detaching from the undersurface. This in turn would make the car rebound on tyres and springs, opening up the gap, and re-establishing the flow and thus the downforce.

Where your CP was would give either porpoising, with the entire car moving up and down, or the even more disconcerting, galloping, where it not only moved in the heave mode, but also in the pitch mode.

In its worst manifestations this would give drivers a rough ride as they bounced from bump-stop to droop-stop. As Keke Rosberg once complained to me when describing it: 'It's difficult aiming at the apex when the helmet is shuttling up and down and one only gets a stroboscopic view of the track.' The initial early attempts to control this by springing or damping did not get very far as the main culprit was the tyre, bouncing at its 4.5Hz characteristic frequency. The only way to get away from it was to work away on the venturi and associated aero gubbins to avoid the downforce loss, even to the extent of reducing total downforce, as a more controlled downforce was preferred to the 'ride 'em cowboy' mode.

Ground rules

The increase of cornering speeds brought on by all this pushed the powers-that-be to ban it all, bringing in the flat bottom that plagues all forms of racing now. The subsequent unintended consequences from the lift caused by big, flat slabs of surface area when in a wrong incidence is with us to this day. But ground effect know-how in the racing world has far outstripped anything the aviation industry has produced in that area. The complexity of modelling tyres for scale wind tunnels and the evolution of CFD for simulation derived from that need.

So why not commemorate Bernoulli's achievement by bringing back ground effects? It could rid F1 cars of their baroque wing arrays, they would be less affected by the leading car's wake, and provide more crush structure on the sides with bigger sidepods. Sounds good to me ...





www.WOODFORDTRAILERS.com

HIGH QUALITY TRAILERS FOR CLUB, PRIVATE AND PRO MOTORSPORTS



Email: sales@woodfordtrailers.com

01327 263 384



Uncertainty principles

Why have grands prix become so predictable – and just what can be done about it?

If a picture is worth 1000 words, and I could draw, I would save myself a load of time by drawing a cartoon of F1 at the moment. I would draw a picture of F1 in a ring, wrestling with itself. There would be no sign of anyone refereeing the contest or checking for fair play; the spectators would be either shouting out encouragement or advice, while those at the back would be shifting towards the sign that said *Exit*. At the edge of the picture would be a group of well-known high rollers in negotiation with a group of unknowns, with large bags marked '\$\$' on the table.

Right now, such a wrestling match makes a poor substitute for an F1 race, but at least the outcome is uncertain. And herein lies the problem: F1 has become too certain. By design!

While researching this article, a number of phrases have popped up, either written or spoken: 'Nothing is certain. That's why it is exciting.' (a SkyBet advertisement). Or: 'We do not read the end of a book first.' Then there's: 'Sport is drama with the ending unwritten.'

Yet the perception of F1 at the moment is that the outcome is all too certain, and that there are many alternatives to divert people's attention and leisure funds, where people can experience excitement through uncertainty. In my pre-season review of F1 following the Jerez test, I concluded that: 'And thus a reasonable prediction for the new F1 season would be for Mercedes and Williams to continue achieving at the level they achieved last year, while the others, er, well, we will have to wait and see ...'

'... The Ferrari looks good, with Sebastian Vettel obviously revelling in the car's handling. Renault and Red Bull stuttered at Jerez with trivial problems. And McLaren-Honda? The body language of its personnel did not correlate with what was happening on track and so it remains to be seen if their optimism is justified. I have my doubts, but look forward to being proved wrong.'

University of Williams

I am in no way claiming credit for these predictions; they were obvious, almost certain. Ferrari had cracked the new powertrain code; Renault had not and were fraying under Red Bull pressure; and Honda frankly didn't look as if they knew how to. Meanwhile, Mercedes and Williams simply maintained continuity.

It is also now clear that there is a certain factor in running the engineering at a successful team, as

the 'family tree' below shows. The technical director of each of the current top three F1 teams has been influenced by Ross Brawn. He, along with Adrian Newey, were both educated at The University of Formula One Engineering (aka Williams Grand Prix Engineering) whose vice-principal was Patrick Head, now Sir Patrick Head. Some legacy!

But where else has the uncertainty gone? In truth we don't like uncertainty in our lives. We invest in houses and pensions; we buy cars with multi-year or 100,000 mile warranties; and take out comprehensive insurance to cover much of what

engines were allowed, and there was no limit on the number of engines blown up in the season. When rpm was limited and the number of engines per season controlled, reliability had to become a science. Cosworth for one developed a reliability schedule based on extensive full powertrain dyno running, such that the life of an engine could be predicted based on its duty cycle and history – just like the gas turbine engines on an aircraft. That technology found its way into Mercedes HPP along with many key Cosworth personnel. *Gearboxes* still give problems, but again, limited numbers per season have led to sophisticated test rigs and much greater reliability.

Chassis: brakes are the Achilles heels of the chassis, being hot and rotating, but close monitoring of their wear and temperature allows safe use, even if performance has to be curtailed.

Racing certainties

Then there's *tyres*. A lack of competition limits the risks a tyre company will take, and allows the manufacturer and teams to learn their performance and wear characteristics. Temperature and pressure sensors enable them to be kept within their operating parameters, in the same way as brakes.

Accidents: the emphasis following Ayrton Senna's and Roland Ratzenberger's fatal accidents has been to still allow drivers to lose control, but to try and prevent the consequences becoming serious. Extensive gravel and tarmac run-off areas, better barriers, better race control, and driver penalties for aggressive racing and even errors, has led to accidents becoming an infrequent source of excitement.

Drivers: the emergence of the driver-in-the-loop simulator as a substitute for testing has enabled teams and drivers to learn their cars and the next circuit, and practice every scenario and eventuality before an event, such that the chance of the unpredictable happening is greatly reduced. Every driver control on the car, except the brakes, is now power-assisted. Drivers use the very latest physio' and dietary technology to ensure that they are fully fit. It is no wonder that after a two-hour race a driver hardly breaks out in a sweat.

Strategy: the same simulation technologies apply to the way the team conducts the whole event, particularly the race. All possibilities are predicted and the unexpected is unacceptable.

The combined technologies of full powertrain, full race simulation on dynos, 600-plus sensors on the cars, driving simulators, strategy analysis

F1's technical director family tree

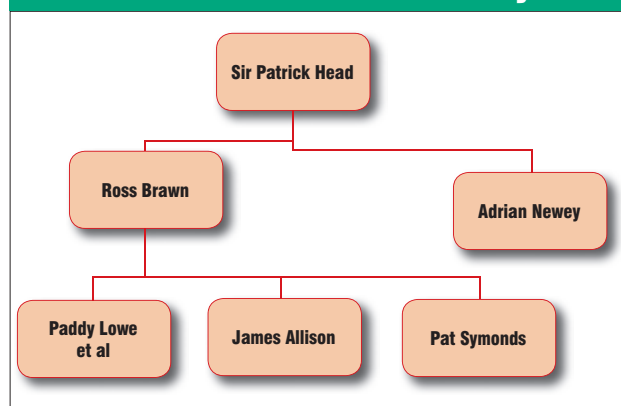

we do. We want our mobile phones to instantly connect us, wherever we are. We even demand compensation when something goes wrong. We want certainty in all the important things in life and industries have developed to provide this. Some of these same industries are involved in F1, either as suppliers of powertrains, tyres, fuels etc., or as investors and sponsors, and they too want certainty. Maurizio Arrivabene: 'It is unacceptable that the wheel nut does not go on first time.' Ferrari, again, gave Kimi Raikkonen a car with an uncertain throttle response and now threatens to let him go if he can't do better than spin.

Even Mercedes' strategic glitch at Monaco, which was probably the highlight of the entertainment in that race, elicited the comment: 'We will be taking steps to make sure it can't happen again.' Pity!

So how has F1 slipped from exciting uncertainty 20 years ago, to less exciting certainty now? I believe there are many factors, but first let us analyse what was, and indeed often still is, uncertain in F1 and what has changed.

First, there's reliability. *Powertrains*: when engine development was unlimited, more power, mainly through rpm, was sought for each race, qualifying

software, Failure Mode and Effects Analysis (FMEA), better design and manufacturing using computer-based technologies, and the introduction of limited life powertrains and gearboxes, reduced testing, driver penalties, and safer circuits and race procedures have all but eliminated uncertainty and the excitement this brings for those watching the racing. This situation is never going to be reversed by regulation.

What can be done?

For those that seriously follow Formula 1 and delve into the technical, political and sporting goings-on, it is still fascinating. For an engineer, the technical supremacy of a team or manufacturer is often awesome, but that will not pull in the casual fans or viewers, who are out there casting about looking for something to excite and entertain them.

What can be done to resolve this problem and why is it so hard to bring about the necessary change? An immediate answer is that the problem of Formula 1 (if there indeed is one) has not been defined. All that has happened is that numerous and varied solutions are being chucked at it, from more speed to more difficult to drive cars; from more risky to artificial sporting regulations; from more money for small teams to 'franchised' cars. Then these are immediately batted back by those who believe the problem is different, or who have other agendas. In order to progress F1 must decide what it wants to be, i.e. what combination of: (1) A technical endeavour involving OEMs.

(2) A sporting contest to determine the best car and driver in the world (first define what you mean by car – relevant to road cars and highly complex, or purely a simple racing machine, built to entertain).

(3) A business to attract the cash of the public, sponsors, automobile industry, and other business.

(4) Where the profits should go: investors, participants, or reinvestment in the sport?

(5) An entertainment to compete with the Olympics, football, computer games, reality shows, soap operas etc.

Who decides? I suspect that is the problem the Strategy Group is wrestling with. It used to be Bernie Ecclestone and Max Mosley, working together, emerging from the FISA-FOCA war with a vision. That vision was delivered in spades, still exists, and still works pretty well. But nothing in business is allowed to stand still and a whole new vision for the future is required, one that does not destroy what has already been built, but is adapted for the very different world and demographics we now live in. That is a really tough thing to do, and is why there are clever people in charge.

Returning to the issue of excitement through

uncertainty, I personally do not believe much can be achieved through the technical regulations. Yes, the car can be made faster, but harder to drive? I doubt it. The engineers now know how to make engines, chassis, aerodynamics, and tyres with benign characteristics, and they're not going to forget that.

Whether the technical regulations should attract OEMs is one of the business issues to be resolved. The sporting contest between drivers is essential, but must be balanced against entertainment and purity – more on this shortly. I do not know enough about the business side of F1 to comment; it just needs resolving so that the sport is sustainable for the participants.

In the current climate of engineering and strategic certainties, any team or OEM that

The technical supremacy of a team is often awesome, but that will not pull in the casual fans or viewers



Mercedes running first and second at Montreal this year, a predictable sight in F1 in 2014 and 2015, but what can be done to bring the uncertainty back in to the sport?

brings more or better technology to bear on F1 is going to move ahead and win regularly and predictably, which is not entertaining to most people. Mercedes' advantage is currently such that anything unpredictable, such as Hamilton's five-second penalty for crossing a white line in Austria, has no effect on the outcome. If one of the Mercedes drivers falters, the other wins; where is the excitement in that?

The only way to increase the excitement is to bring the performance of all the cars close enough together so that the tiniest uncertainty, those that the teams cannot eliminate, affects the outcome. Every other form of motorsport does that to some degree or other, either through spec cars, spec engines, or highly restricted technical regulations; BoP, EoT, etc. And it works. However, F1 and its pundits look down their noses at such 'non-traditional' measures, even as they claim it is currently boring. They also decry 'artificial' sporting regulations to enliven the show: success ballast,

reversed or random grids, multiple shorter races etc.; all these mimic devices that are used in ancient games to make them entertaining: dice, cards, even increasing the number of snakes near the top of Snakes and Ladders to allow competitors to catch up. Chess, that ancient game that does not rely on luck but rather on strategy alone, does not make a good spectator sport. In motorsport, only rain brings the true element of rolling the dice.

Entertainment has to be balanced against technical contest and human sporting contest. Until the brains that control F1 stop talking about solutions and apply their efforts to defining and agreeing what the problem is and what is the objective for F1 in the future, there is little chance of progress. For me, the future of F1 is the only issue for my mid-season review this year. The

rest is predictable, and anyway who knows what each team and powertrain developer is doing? I still believe it is a great pity more technology is not revealed to attract those that are interested in such things. The main technological development seems to be how to make a short nose pass the crash test. Surely other things are happening?

New blood

I recently met with Ron Ayers, the designer of Bloodhound SSC, the Land Speed Record project. Bloodhound has promoted a pioneering educational side to the project, for which it has UK Government support. They have engaged with 6000-plus schools worldwide, including 800 in South Africa. Universities allied to the programme have seen a 100-plus per cent increase in applications for engineering degrees, and some have been able to double their intake. Bloodhound driver, Andy Green, recently gave an interview to

a newspaper in China with a circulation of 175 million. *The Discovery Channel*, a Bloodhound partner, estimates that by the end of the 1000mph attempt Bloodhound will have a worldwide exposure of around 2.2 billion people – just over 30 per cent of the world's population, and nearly 50 per cent greater than F1's exposure! If Bloodhound can engage people, particularly young people, in engineering and technology, surely F1 can too.

I also believe that Formula 1 has missed the point of the Internet. It engages with people through social media, for free, but in exchange for their details. One may be wary of this exchange, but if F1 does not engage by whatever means, with young and old, it will never involve them to the extent that they become that essential part of any business – the customer. There is an old engineering adage: 'If you define the problem completely and correctly, the solution is immediately obvious.'





SIMULATOR HIRE / SALES

Corporate Events | Product Launches | Trade Shows | Team Building | Driver Training | and more

HIGH END TECHNOLOGY UNCOMPROMISED EXHILARATION

Clients Include:



www.radicalsimulation.com

info@radicalsimulation.com

+44 (0)7891 235475

What's new?

Racecar Engineering looks at the new season's key regulation changes made for 2015 and sees how the teams are reacting to the new guidelines

By SAM COLLINS

At first glance, there is little change for the 2015 Formula 1 season, especially when it comes to the rulebook. There have been barely any changes over the winter, and the few that there have been introduced do little to affect the overall design of the car. Changes regarding the noses and the size of the front impact structures have led to the front of the car looking different, and visually the rest of the car looks similar compared to last year. As always, however, there is more to the story.

In 2014 the FIA introduced revised rules relating to the height of the front impact structures, but an unintended consequence of this was the 'adult entertainment' look of the front of the cars. They were widely ridiculed and for 2015 new, much wider front impact structures were introduced, as well as a more gradual gradient on the nose itself and the front of the chassis.

'An awful lot of work had to go into the nose,' says Pat Symonds, chief technical officer for Williams. 'At first glance, the regulations look quite innocuous, but in reality there is a lot of work there. The new front bulkhead and nose geometry had much more of an impact than we had initially anticipated and the effect on the aero was profound. The team has worked hard on pulling back the deficit these regulations have made for us. It is about the balance of aerodynamic solutions that can structurally get through the crash test too. Aerodynamically we wanted quite a short nose, but you want quite a long nose to get through the crash test, so there was some balancing to do there.'

This season sees a wide range of solutions of nose design on display along the pitlane. Teams such as Ferrari, McLaren, Sauber and Toro Rosso have opted to use wide, long noses, where the tip of the front impact structure sits forward of the leading edge of the front wing. Others, such as the Mercedes and Lotus, use shorter noses that sit behind the front wing. With both solutions, the new wider front impact structure sits in the area where teams want to get as much air under the nose as possible, so they are experimenting with different ways of achieving this. The Lotus twin tusk design of 2014 has been outlawed.

'The noses were an aerodynamic loss,' James Key, Toro Rosso technical director admits. 'It changed the flow in that area and as a result I think noses will be a development item this year, perhaps more so even than last

year. We have things in the pipeline in that area that will improve things. Whether everyone will devise the same solution remains to be seen, but there is a lot more to come.

'We crash test at Cranfield and there have been a lot of visits there, and not just us either, to the point that our car will look totally different by the start of the season.'





**‘With the 2015
power units
everybody can
change everything’**

— Andy Cowell



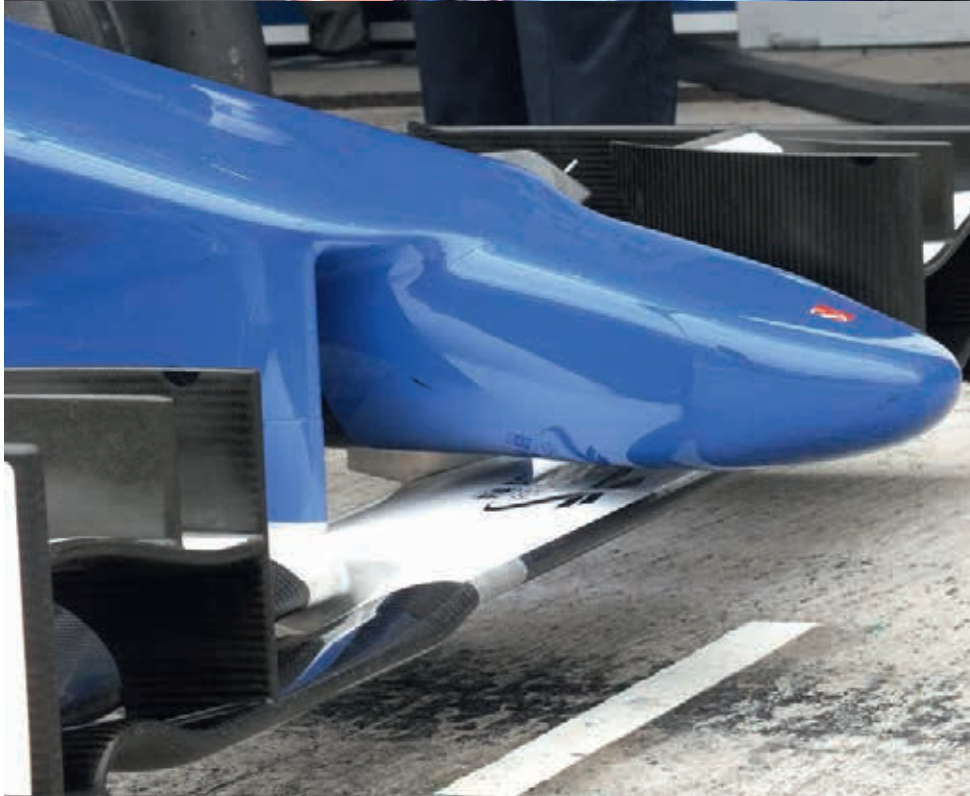
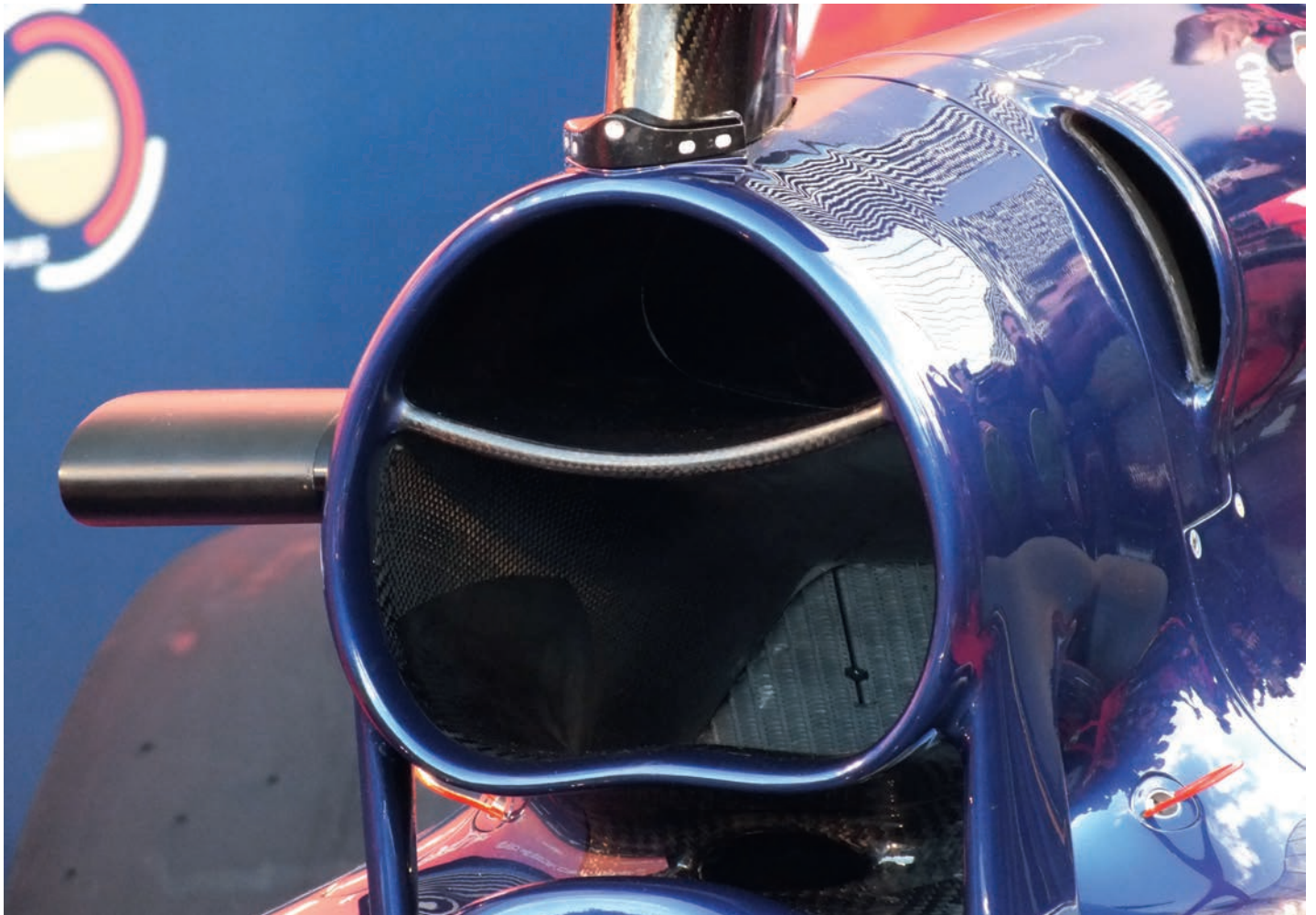

Top: The Toro Rosso features some interesting ducting around the roll hoop, most noticeably the car has grown 'ears'. These additional ducts cool systems toward the rear of the car, likely the transmission and possibly the MGU-K

Above: The C34's nose section is now bigger in volume and lower to the ground, which has a considerable impact on the aerodynamics of the entire car – the nose and front wing play a key role in determining how the air flows around the front wheels and how effectively the central and rear sections of the car function aerodynamically

Another consequence of the revised nose section is that a number of teams, including Ferrari, Sauber and McLaren, have revised their 'brake cooling' aerodynamic elements and the wheel design itself. Some, including McLaren, have also used so-called 'blown nuts' to optimise flow around the front wheels and in the wake of the front wing endplates.

The nose changes have also had a major impact on the packaging at the front of the cars, especially on the front bulkhead which traditionally houses the inboard front suspension pickups, the torsion bars, dampers, master cylinders, steering rack and a number of electronic components. However, this area has been substantially reduced in size on a number of the 2015 cars, and it has led some teams to explore unconventional solutions, particularly in terms of the suspension. 'It's a big packaging exercise,' says Key. 'We had a strict rule of giving the guys the surface and saying everything has to fit inside that, and they achieved it all. At the moment the suspension is quite conventional, with torsion bars and dampers, but we have a lot of ideas, a long list of stuff, but we have not put that on the car yet.'

A more major but almost invisible rule change has had a huge impact on the suspension systems used in F1. Part-way through the 2014 season, the FIA announced that it felt that some, if not all, of the



hydraulically interconnected suspension systems used in Formula 1 were illegal. The governing body felt that the systems infringed article 3.15 of the technical regulations and that they constituted a moveable aerodynamic device. Strictly speaking, the systems did not breach article 3.15, but no team felt it worthwhile to test that stance and all of the teams removed the systems with immediate effect. For 2015 they have now formally been banned with the addition of the wording 'any specific part of the car influencing its aerodynamic performance must remain immobile in relation to the sprung part of the car.' This could also conceivably outlaw McLaren-style suspension 'blockers'.

With this rule change, and the packaging demands at the front of the car, many teams are taking the lessons learned in the years leading up to 2014 with the hydraulically interlinked suspension, and are applying them in a different way. The Marussia team had developed something 'different to anything seen in F1 before' for its stillborn MNR1 2015 design, while others are rumoured to be developing systems that drop torsion bars altogether.

Some other relatively minor safety rule changes have also been introduced in the wake of Jules Bianchi's crash at Suzuka last season. In 2015, the Zylon anti-intrusion panels, which are bonded to the sides of the monocoque, have been extended upwards and rearwards.

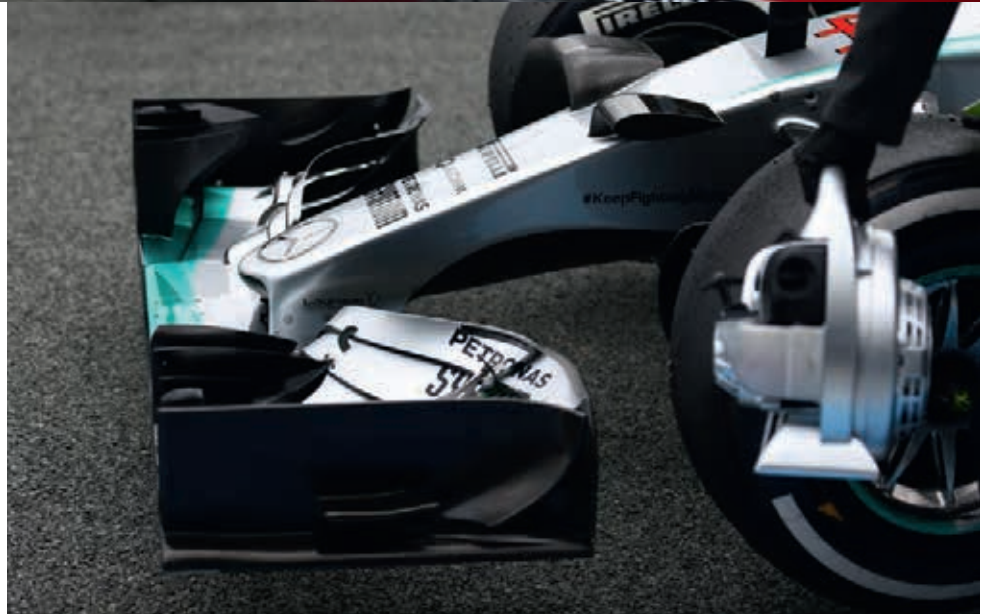

Top: The rear of Ferrari's SF15-T is noticeably different from the 2014 car. The bodywork is now more tightly sculpted, and is a result, in part, of using more efficient radiators for improved cooling

Above: Mercedes and Lotus have opted for shorter noses that sit behind the leading edge of the front wing

With so few rule changes, the teams and power unit manufacturers have been working hard on understanding the lessons of 2014 and optimising their cars around the power units.

The only major rule change in terms of power units is the reintroduction of variable inlet trumpets, a feature that could be used to improve efficiency and flatten out the power curve somewhat. It is a technology that is thought to feature on all of the 2015 power

units and is a subject which we will cover in greater depth in a future edition.

When the new engine formula was introduced at the start of last season, it allowed for annual updates to the power unit on a gradually descending scale, eventually arriving at a fully frozen specification by 2019 (see V23N11 for full details). Each year until that point the manufacturers can present a set of updates to the FIA for their power units which





Top: The back end of the McLaren is the tightest in the field and the sculpted rear ends are a particular trend in 2015
Middle: A number of teams have redesigned their front wheels to improve airflow around the front of the car following changes to the rules around the nose. Above: Red Bull's Daniil Kvyat knocked the car's wing off during testing at Jerez and a lack of a replacement meant the team had to run some basic installation programmes with a wingless car while a new one was being flown out from the UK

would then be homologated for the season to come. After homologation each year, no updates other than those made for the reasons of reliability, safety or cost would be allowed. The trouble is that, for some reason, the FIA failed to publish a homologation deadline in the 2015 rules, which the manufacturers have now deemed to be tacit allowance to gradually phase in updates as the season goes on.

In 2015, up to 48 per cent of the power unit can be replaced (subdivided into 32 tokens), with the only elements of the design to be fixed being some dimensions including cylinder bore spacing, deck height and bank stagger, the air valve system and some aspects of the crankshaft design, so some manufacturers are clearly planning to bring in new parts during the year within that 48 per cent allowance.

Despite this, Mercedes has claimed that its PU109B power unit is essentially all-new, despite the rules seemingly stating that they can only be 48 per cent new. 'I don't think there are many parts carried over from last year, I think the majority of parts are changed either for performance or reliability,' explains Andy Cowell, Mercedes AMG HPP managing director. 'This power unit is completely new. If you look at the table of tokens, you can change a lot. Combustion is down as three tokens for example. Changing that means a new cylinder head, piston, valves, injector and some associated parts, all within those three tokens. So when you think about it, the 32 tokens are actually very, very generous. Coupled with that, you can change anything for reasons of reliability, and everyone has to do more miles. Basically in 2015 everyone can change everything, because of the 32 tokens and the reliability increase required to go down from five power units to four.'

Stricter gearbox rules

This has left the teams able to focus on integrating the power units better, leading to the cars featuring smaller cooling apertures as more efficient ways to cool the cars have been found and introduced. For example, Ferrari has changed the type of radiator cores it uses. 'The reduction in cooling is really just a case of second time around the loop – the heat rejection and cooling requirement numbers for the engine have not changed, it is just a case of looking through everything again and optimising,' adds Adrian Newey of Red Bull.

In terms of transmissions, little has changed year on year, with each gearbox still having to last for six races. 'We count it as 3300km,' explains Xtrac's technical director Adrian Moore. 'This is made up of 250km on Saturday, and 300km on Sunday. Of course, not everybody does this as it depends on how far they run on Saturday morning and how far they get in qualifying and the race, but that is our target. The eight homologated gear ratios were designed to be in the gearbox for this mileage.'

REIS

Insurance for motorsport businesses, teams,
suppliers, event promoters and circuit owners



As motorsport specialists, we understand what our customers need when it comes to insurance. We also understand motorsport involves the inherent non-standard activities and risks that may not be found elsewhere.

Our experienced and friendly team take care to ensure that each policy is tailor-made to suit individual circumstances. For instance, our Commercial Combined product provides the full benefits of a motor trade policy and includes the flexibility that's needed to operate in the motorsport arena.

So, whether it's to insure your business, team, specialist vehicles, products, equipment, premises, employees, circuit or venue, REIS can get you covered.

For a quote and to find out more, please call: 0115 965 1050

contact@reis.co.uk



www.reis.co.uk

REIS is a trading name of Insurance Factory Limited.
Insurance Factory Limited is authorised and regulated by the Financial Conduct Authority (No. 306164).
Registered Office: 45 Westerham Road, Sevenoaks, Kent TN13 2QB

REIS
**We Know
Motorsport.**



Toro Rosso's STR 10 managed 353 laps during testing at Jerez. The car's speed is described as solid, not spectacular

Manor reborn?



The collapse of two teams and the reported financial troubles of three more made for pretty bleak reading at the end of the 2014 season. But at least one of the two failed outfits is trying to fight back – Marussia has come out of administration (the British equivalent of chapter 11 bankruptcy) and hopes to get onto the 2015 grid under the Manor Racing banner. The team intends to run its pair of 2014 specification Marussia MR03 chassis at the start of the season in a move that has proven somewhat controversial.

The tubs would be modified with the larger anti-intrusion panels required by the rules, but otherwise the cars would be entirely legal to run in 2015 with the notable exception of the nose. In January this year the F1 strategy group indicated that

Marussia and Caterham would be allowed to start the season with 2014 specification noses, but the details of this remain unclear.

'The team has been busy preparing its 2014 cars and at the same time it is pressing on with the development of its 2015 car to ensure it can supersede the 2014 car as soon as possible,' reads a statement from Manor Racing. 'The team has a significant number of staff already working on both its 2014 and 2015 cars. It also has the benefit of being able to recruit further staff from the rich pool of experienced and talented F1 personnel who were left unemployed following the closure of Marussia and Caterham and job cuts made by other teams.' It is likely that Manor will not have the resource or capability to build its MNR1 design as the wind tunnel model

was dismantled and the parts sold off at auction now reside in two separate private collections. In addition the team's factory in Banbury, England, has been taken over by the Haas F1 Team along with its computational capability (and reportedly the design data of the MNR1).

Its likely recourse will be to build 'B Spec' MR03s either using new tubs made from modified moulds, or to modify the two existing chassis by replacing the forward upper section of the chassis. Additionally, packaging Ferrari's 2015 specification power unit may be problematic within the 2014 MR03 bodywork, so the old spec Ferrari 059/3 power units may be used as they remain legal under the 2015 rules, although they do not have the required longevity, which would see the team incur grid position penalties.

One change to the 2015 sporting regulations means that teams can no longer make changes to their gear ratios during the season. 'Last year teams were allowed one instance of a ratio tooth count change during the season, i.e. in effect they could decide to change some or all of their eight homologated ratios for up to eight different homologated ratios', Moore elaborates. 'They were also allowed five jokers, where they could change ratios from a sealed gearbox to identical items without penalty. In 2015 the ratio tooth count change is no longer allowed, and neither are the jokers.'

Far too often in the world of sportscar racing, an erroneous statistic is repeated claiming that the winner of Le Mans does more running in one race than a grand prix car does in an entire year. When looking at the gearbox it is clear that this is not the case. 'With our ultra high specification gear design, materials, heat treatment and finishing processes the gear ratios are intended to be durable for at least the 3300km,' Moore claims. 'In 2014 the winning Le Mans car completed 379 laps in the race which is 5165km. Comparatively an F1 car's gearbox is sealed for 3300km, which is actually more than 60 per cent of a Le Mans distance – significantly different to a few years ago when F1 gearboxes were overhauled after every race.'

But despite the stability of the regulations it appears that few, if any, of the teams have carried over their transmissions from 2014. One notable trend in 2015 is toward very tight rear ends on the cars, to the point where McLaren has dubbed the MP4-30 the 'Size zero racing car'.

More compact rears

This is an area of focus for almost every team and has led to not only revised transmissions but also substantially different suspension layouts. 'The suspension is very different,' Key reveals. 'We heavily revised what we did last year for both aero and suspension reasons. With suspension you have the structural stuff, like compliance levels, but aero wants to have the thinnest possible elements, whereas structures want the thickest possible. You have to look at all of it, the mechanical grip, the ride and the platform control. Suspension has a huge aero influence so you have to go round a loop of how to optimise things, and we have done that more with this car than ever before.'

Some teams have gone even further and Force India has replaced the torsion bars at the rear with a new hydro-mechanical system. While the new VJM08 had still to be seen as RCE went to press [note, the 'B' spec was introduced in July], it seems likely that these changes were made for packaging reasons.

Overall, though, it seems that all but one of the 2015 cars taking to the grid is a mild evolution of the same teams 2014 concept, just with a great many detail refinements, and not a few very small innovations. 

Liquid Level Sensors

GSlevel

COMPATIBLE WITH FUEL, OIL & COOLANT

SUPER LIGHTWEIGHT

VOLUMETRIC OUTPUT OPTION

FLEXIBLE MOUNTING

SHORT LEAD TIMES

FIA HOMOLOGATED



NEW GSlevel 4223



Proven racing pedigree:

F1, LMP1, LMP2, GT, Rally, V8, Indy, NASCAR, RSR plus others

Get a quote at gillsc.com/racing or call **+44 (0)1590 613900**

GILL

gillsc.com



mezzo
TECHNOLOGIES

Mezzo designs and fabricates micro channel heat exchangers for a number of industries including automotive racing, aerospace and defense.

Mezzo's products deliver superior performance in terms of increased heat transfer, reduced weight, and decreased volume. **Mezzo's** products are also very damage tolerant, easily maintained, and reasonably priced.

Mezzo is now an approved supplier of radiators for IndyCar. **Mezzo** won the 2010 Louis Schwitzer Award for innovation for its micro channel radiator and will continue to develop its technology for high performance racing applications. **Mezzo** products are currently being used in high performance racing including F1, GT, IndyCar and LeMans.

Mezzo takes pride in handling the toughest thermal management problems. **Give us a call!**



10246 Mammoth Avenue, Baton Rouge, LA 70814, USA

Tel: +1 (225) 442-6965 Fax: +1 (225) 706-0198

www.mezzotech.com

email: kelly@mezzotech.com

Efficiency drive

How efficient is a modern Formula 1 Power Unit and what do the manufacturers really have to play with?

By PETER WRIGHT

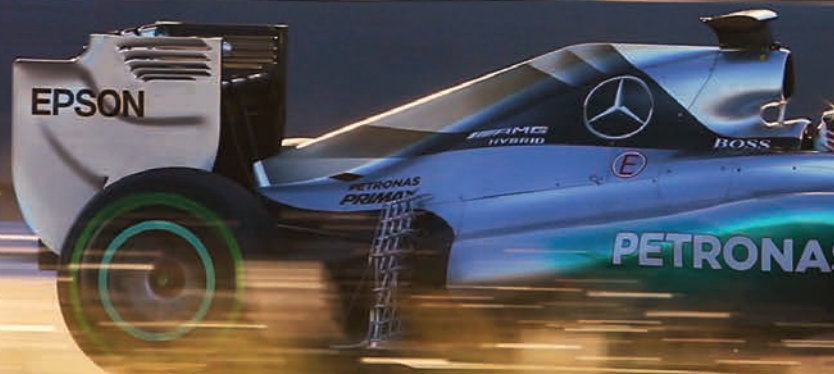

The challenge set by the FIA's regulations is to see how fast you can go around the racetrack for 200 miles using a limited amount of energy

Someone once famously said, generally attributed to Albert Einstein, that the definition of insanity was doing the same thing over and over and expecting different results. F1 is results driven, and moves quickly in response to results below expectations. It would seem that Formula 1 teams have taken this quotation to heart.

Ferrari, McLaren, Red Bull and Lotus have all instigated changes of management, and/or engine, and/or drivers, and/or engineers in an attempt to halt the slide in results experienced with the introduction of the new regulations in 2014. Meanwhile, Mercedes and Williams have changed almost nothing for 2015. And thus a reasonable prediction for the new F1 season would be for Mercedes and Williams to continue achieving at the level they achieved last year, while the others, well, we will have to wait and see.

To gain a greater perspective it is necessary to step right back and look at the bigger picture at the top level of motorsport. F1 and its equivalent GP formulae pre-1950, has always been an effective promotional tool for the motor industry, should they have a reason to promote the image motorsport provides. Mercedes created much of the brand identity it has today through technical superiority in

Grand Prix racing during the 1930s, and by achieving that superiority by a significant margin. It cemented that reputation post war, but since then it hasn't seen the need to commit to F1 until 2010, when it bought Brawn GP and a works Mercedes-Mercedes was seen for the first time since 1955. Why now? Because Mercedes recognises that automotive engineering is going through seismic changes with the need to reduce fuel consumption and CO₂ emissions, and it foresaw the need to promote its technical superiority in these new technologies and to re-establish the brand as the best in the new era. It has been reported that Mercedes' promotional yield from F1 in 2014 was worth \$2.5 billion, for an expenditure of \$400 million.

Ferrari also wishes to promote its brand and its cars through motorsport, but the image it wishes to promote is not that of economy. Motorsport, i.e. F1, is its sole means of advertising its road cars, and it must succeed regularly to justify the price it demands for its cars. It is inevitable that Ferrari will use whatever it has at its disposal in terms of influence to maintain F1 in that role. The other manufacturers, Honda and Renault, are desperate to receive reflected glory by beating Mercedes and Ferrari. McLaren-Honda may even find it has an

identity crisis as McLaren wishes to promote performance, while Honda's main market is becoming focused on high efficiency cars.

Thus we have multiple promotional objectives for the key stakeholders in F1. The volume motor industry wishes to promote economy and sustainability. The specialist performance sector wishes to promote an image of overwhelming performance. Red Bull wishes to promote its own brand image, the main attribute of which is to enable people to stay awake. FOM, the operational arm of CVC, simply wishes to entertain people sufficiently that they are happy to part with their money. F1 is a fine balance between business, entertainment, and marketing, and as the world changes in all these three areas, F1 is struggling to keep up. So focused and responsive to the engineering challenge, it seems lost in these other disciplines.

Anyway, I found myself in Jerez for the first F1 test of 2015. The nature of the current F1 regulations is such that the technical challenge set by the FIA's regulations is to see how fast you can go around the racetrack for 200 miles using a limited amount of energy delivered at a limited peak rate. Thus the technical story I have tried to gather at this start of the second year of these regulations is: a) What has F1 achieved so far? and b) How?





Mercedes enjoyed a positive Jerez test – the team’s cars managed 515 laps, 40 per cent more than they achieved in 2014’s equivalent test

The total energy issued for a race is 4.3GJ (1200kWhr), and it can be used at a peak rate of 1.2 MJ/second, or 1200kW (1609 bhp).

The powertrain designers’ objective is pretty straightforward: to deliver as much of the 1200 kW to the flywheel as possible, when required. The chassis designers’ objective is more complex: to apply this power to cover the 200 miles as quickly as possible, without allowing the integral of the power applied to exceed 1200kWhr. The drivers’ objective is to deliver this strategy during the race weekend.

Before 2014, a 200-mile F1 race typically used an unlimited 6.6GJ of energy to complete, and the peak rate at which it could be delivered was not limited, other than by the capacity and peak RPM of the 2.4-litre V-8, 18,000rpm, NA engines. The masters of achieving the new objective are undoubtedly Mercedes, and so I set out to find out the ‘What?’ and the ‘How?’ from Andy Cowell, managing director of Mercedes AMG High Performance Engines. The key question I asked him was ‘Where does all the energy go?’

First things first. The figure of 1200kW input power equivalent to the 100kg/hour regulated fuel flow rate is Andy’s figure, and equates to a fuel energy density of 43MJ/kg – significantly more than the FIA-regulated WEC fuel at 39.5MJ/kg. This is likely explained by the high level of bio-components in the WEC fuel; ethanol has an energy density of just 26.4MJ/kg. F1 does not directly regulate fuel energy density.

Cowell was never going to reveal the output of either the 2014 or 2015 Mercedes engine, so a different approach was necessary. I offered up the figure of an SFC = 200g/kWhr that I had heard from a reliable source. This figure gives:

Input power (fuel):	1200kW (1609bhp)
Output at crankshaft:	440kW
Output from MGU-K (generated by MGU-H):	65kW
Total at flywheel:	505kW (675bhp)
Overall efficiency:	42%

I have made an assumption here, based on the rumours and figures that always rush

in to fill a vacuum. The difference between the Mercedes engine and the other two in 2014 was the amount of power the MGU-H was able to extract from the exhaust. The permitted maximum it can deliver to the MGU-K is 120kW, of which 115kW goes to the flywheel. Based on the further assumption that Renault and Ferrari are just about as capable of generating power from a turbocharged engine, I have estimated the split between crank power and MGU-K power as generated by the MGU-H as above.

Cowell’s reaction was intriguing: ‘That would be the 2014 Renault figure then?’ Now we have something to play with. Adrian Newey stated that Red Bull estimated that the 2014 Renault was 10 per cent down on power compared to the Mercedes, and Renault stated in its 2015 press kit that the new power unit would deliver 850bhp. All teams reverse-engineer the performance of their competitors using the GPS data distributed by the FIA. Factor this in and the numbers would become as follows:

Input power (fuel):	1200kW (1609bhp)
Output at crankshaft:	440kW
Output from MGU-K (generated by MGU-H):	115kW
Total at flywheel:	555kW (744bhp)
Overall efficiency:	46%

All F1 teams reverse-engineer the performance of their competitors using the FIA’s GPS data

McLaren and Honda have teamed up once again and have suffered teething problems in pre-season tests

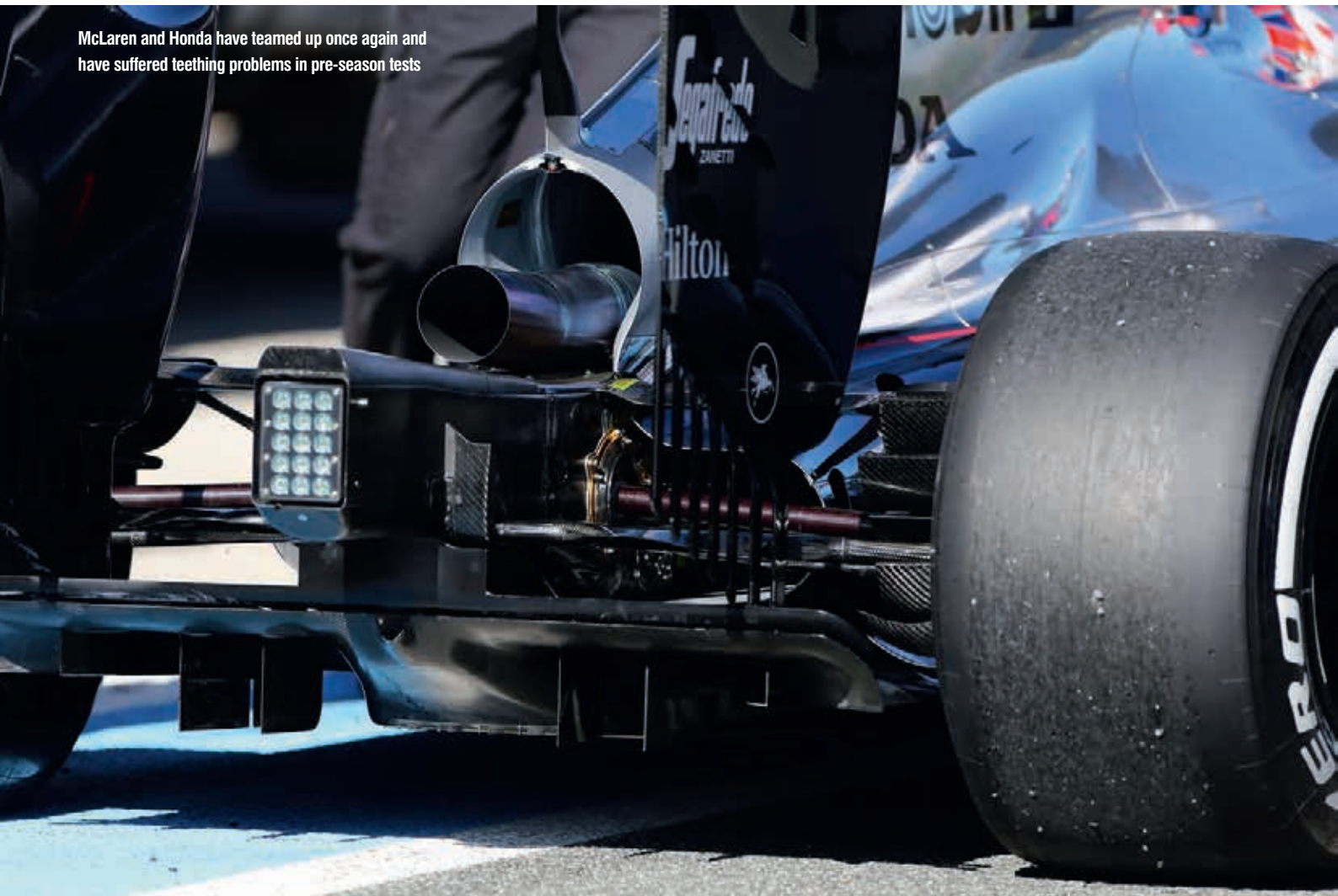

These figures are based on all the additional power coming from the MGU-H.

Pre-2014, NA F1 engines achieved an overall efficiency of around 33 per cent, so this is a remarkable 39 per cent improvement; surely complete justification for the change in powertrain regulations.

Cowell next described some of Mercedes' development philosophy behind this achievement, while being careful enough not to divulge sufficient numbers to enable the full picture to be revealed. He describes the whole process as 'the science of marginal gains': thousands of tiny incremental improvements, which, while almost insignificant in isolation, add up to a significant gain in performance.

It turns out that the limited number of tokens a powertrain manufacturer may use in 2015 – 32 in total – is actually no limitation on what it may change on the engine. Because the 2015 engines are limited to four per driver, compared to the five permitted in 2014, all aspects of the powertrain have to be made more reliable. As there is no limit on the number of components that may be changed for reliability reasons, it is perhaps unsurprising that the engines for 2015 are 'all-new', with 'virtually no carry-over components'. Mercedes' powertrain is no exception.

The core development area of the new breed of F1 powertrains is the combustion chamber (valued at three tokens). For the R&D behind any changes, Mercedes AMG HPP have a single-cylinder research engine at Brixworth, a very sophisticated and comprehensively equipped tool for optimising ports, piston crown, combustion chamber, valve geometry, timing and lift, injector nozzles, coils, spark plugs, and fuel, as well as charge pressure and exhaust systems. Cowell described this ongoing programme as being almost university-like, with scientists, chemists and engineers cooperating in the quest for ever greater efficiency. 'The management of peak cylinder pressures is the key. You have to become the Master of the knock,' he explains. Cue Christie Moore's The Knock Song – an Irish folk song about miracles.

A large part of this research involves Petronas. In 2012, Petronas Lubricants International (PLI), part of the Malaysian state-owned Petronas group, invested €70 million to expand its R&D activities in Turin, at the former site of FIAT Lubrificanti. It now employs 100 people there and is a significant resource for the F1 programme. Dr Andrew Holmes, director of research and technology at PLI, revealed that Petronas had homologated just one fuel in 2014 for use by the Mercedes powertrain teams

that use their fuel. Many hundreds of fuels had been developed and tested, but just one deployed in races. Since the start of 2014, they concentrated their R&D efforts on 2015. If this is indicative of all of the Mercedes AMG HPP's combustion research efforts, it is a revealing picture of an organisation that is clear and confident in the fundamentals of what it is doing.

For 2015, Mercedes have a Bosch 500bar fuel injection system available, although Cowell was not forthcoming about whether the full 500bar is being used or not. There are two issues that have to be addressed: firstly, the pressure signal must not exceed 500bar, and due to the high-pressure pump and the fast response injectors the pressure is 'spiky'. Secondly, there is a trade-off between performance gains and fuel pump power. However, high pressure does offer gains including better control of droplet size (being direct injection, there is little time for fuel to vaporise and so droplet size becomes critical); position of the spray pattern; timing of the injection events (Cowell would not reveal whether there are more or less than five injection events, but this technology is key to shaping the pressure rise in the cylinder); and greater precision of the quantity of fuel injected.



After combustion, the area of most interest is the turbine-compressor and its MGU-H. Road car engine turbochargers are a compromise between flow rate, boost pressure, compressor speed and efficiency. The characteristics of a turbocharger are conventionally expressed as a compressor map. The road car objective is to provide high efficiency throughout the operating range. Modern turbochargers include variable geometry in the turbine nozzle to widen this high-efficiency region. The inclusion of an MGU-H in series with the turbine and compressor enables the turbocharger to be operated as a constant-speed device, and hence there is no need for VG. The design of the turbine and compressor can be optimised around pressure ratio and mass flow.

Cowell was very cagey about both turbine and compressor efficiencies, but it was clear that both are above 80 per cent. Formula 1 does not allow ceramic turbines, and from a comment he made about turbines sometimes being difficult to disassemble from their housings, due to high temperature creep of the turbine wheel, Mercedes would appear to be operating at the limit of permitted materials. The engine is still a tuned engine with individual exhaust primaries leading to the turbine. Variable geometry intake trumpets are permitted in 2015 and they are used on the Mercedes engine. It is clear that tuning of both intake length and exhaust lengths is still critical for the torque curve on these highly turbocharged engines.

On the subject of electrical machine efficiency Cowell was inevitably not much more forthcoming. However, he did state that the 120kW permitted MGU-K delivered 115kW, giving a combined efficiency of the MGU and its control electronics of 96 per cent. An efficiency of each device of around 98 per cent is exceptional. 'It is so difficult to cool these devices – the small size and low surface area of the power electronics and the tight windings of the armature coils make it difficult to get the coolant into close contact with the hot surfaces to transfer the heat away. The eddy current generated heat in the high speed rotor is even harder to remove,' he explains.

As to the final breakdown of energy flows, Cowell was only prepared to suggest a loss

F1 engineering was set an enormously challenging task in 2014, and it has shown just how effective it can be

figure for 40 per cent of the total through the exhaust tailpipe, as being illustrative of what F1 has achieved.

If the only goal of the F1 powertrain regulations was efficiency, and there were no other constraints imposed, what would Mercedes build? 'Smaller engine capacity; fewer cylinders (four or less); lower RPM; higher boost,' says Cowell. The indication is that the 267cc cylinders are too small for ideal combustion, that friction losses are too great and that higher boost could be obtained if single-stage compressors were not mandated.

Road relevance

As to the relevance of all this R&D to future road vehicles, Cowell believes that much of it is directly transferable, in particular: torque delivery; low mass and size; high efficiency combustion; and low heat to coolant. What packaging advantages could be had in a small road car if a typical 140cv passenger car powertrain was built to F1 size, weight, and cooling parameters? Interesting question.

I also spoke to Pat Symonds, chief technical officer to the Williams F1 team. If Williams didn't quite use the available power of the Mercedes powertrain to the greatest effect, they did waste the least in overcoming the drag of the car.

The objective of the chassis designer is somewhat more complex than that of the powertrain's. His task is to waste as little of the available power at the flywheel in getting



Ferrari was fast out of the blocks at the first test after a major management overhaul over the winter

Input power distribution (1,200kW fuel in)

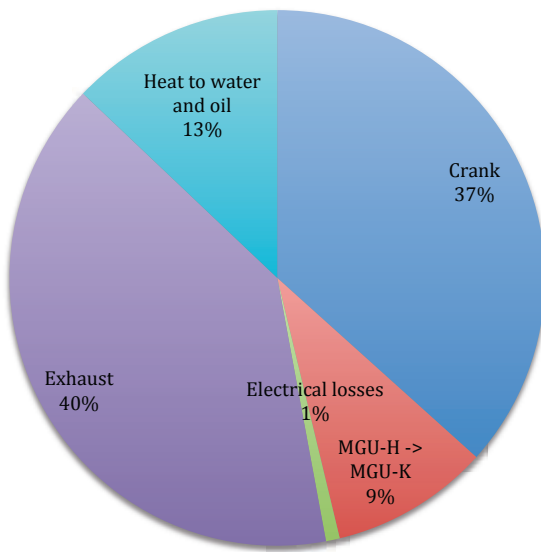

Dissipation of flywheel power (555kW)

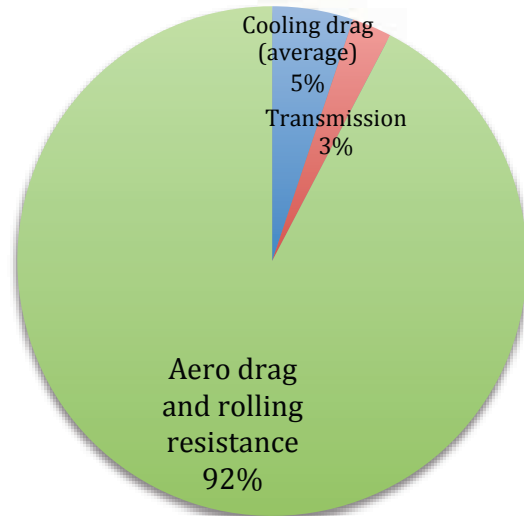

around the circuit as quickly as possible, while using a limited amount of total energy over the duration of the whole race. If it was a simple, straight-line race it would just be a matter of reducing drag as much as possible and choosing a top speed compatible with the fuel flow rate and the total fuel available. But there are corners, and the energy used in the direct exchange for kinetic energy (2.6MJ at Jerez V_{max}), and the subsequent recovery of as much as possible, via the MGU-K, and storage in the batteries is a matter of developing a circuit-specific, driver-executed strategy embodied in the powertrain and chassis software. The driver remains in charge of tactics, i.e. executing the strategy, as only he can deal with what is going on around him. To add to the complexity, drag becomes a compromise with the requirement for downforce to minimise the loss of kinetic energy at each corner.

While the objective may be complex, it is understandable enough, but the strategic trade-offs of powertrain settings, MGU-K use, chassis and aerodynamic settings, and driver options are incomprehensible unless one is intimately involved in performance simulation, race simulation, and the development work drivers carry out in the car simulator, never mind the effect of the best laid plans of the other competitors, accidents and the weather.

Thus one can only look at the information available. Easy parts first: the transmission absorbs 2.5 per cent of the power it is transmitting: 14kW at full power. The resistance to motion at any given speed comes from aerodynamic drag (a function of downforce) + cooling drag (the power needed to dissipate the heat) + tyre rolling resistance + other rolling resistances (bearings etc.). 'Tyre rolling

resistance is mainly a function of toe settings, with camber and pressure only having small effects,' says Symonds. 'Total rolling resistance is small relative to drag. It is hard to separate out the cooling drag from overall drag, because, if we didn't have to dissipate the heat losses from just about everything that produces, transmits or controls power, the whole aerodynamic package would be radically different.'

'What we do is to dig into CFD results to look at radiator loads and hence drag. Running at 30°C and 55 m/sec we see a loading varying from 184N to 371N depending on the cooling exit configuration. Bearing in mind the radiator installation angle, this gives a drag of between around 3.5 points and seven points – so around 3.5 per cent to seven percent of total drag.

'The loads are the loads on the radiator faces themselves, so no account is taken of any turning losses in the ducts or indeed any duct losses or the gains that may be made if full dynamic head were available in the lateral positions of the radiators. It also takes no account of any thrust from heating of the air by the radiators,' Symonds continues.

Taking the total power absorbed by drag and other resistances, at max speed, as 555kW, less transmission losses of 14kW = 541kW, then cooling absorbs 19-38kW, depending on how the car has been setup.

With these figures, we can now do a power audit of the car at full power and full speed:

Input power (fuel): 1200kW
Output at crankshaft: 440kW
Output from MGU-K (generated by MGU-H): 115kW
Total at flywheel: 555kW (744bhp)

Losses to water and oil, inc. internal friction: 155kW
Loss to exhaust: 480kW
Electrical losses (MGU-H + MGU-K): 10kW
Total losses: 645kW (865bhp)

Transmission losses: 14kW
Power to cool car (average setup): 29kW
Power to overcome drag and rolling resistance: 512kW
Total Power to propel car at V_{max} : 555kW (744bhp)

Which leaves the issue of kinetic energy recovery. Energy management in F1 is so important to raise performance that there is no chance of finding out how teams go about it. All we can do is to consider the fundamentals:

In the simplest terms, the powertrain ECU manages the fuel energy, responding as determined by the software to the driver's demand for torque, apportioning crankshaft torque and MGU-K torque according to its best estimate for fuel efficiency. MGU-K energy can either come from the battery (limited in

“If we didn't have to dissipate the heat losses from drag, the whole aerodynamic package would be radically different”

Sauber failed to score during the 2014 season but caught the eye at Jerez with some fast times



quantity to 4MJ/lap or 33.3 seconds at 120kW, but free in terms of fuel use), or from the MGU-H (unlimited but only available when the compressor doesn't need it, and only semi-free in terms of fuel).

The chassis engineers and driver have to manage the battery's energy. Acquiring the permitted 2MJ/lap is the first priority, then returning as much as possible at chosen moments, up to 4MJ/lap, is determined by the circuit strategy and the driver's tactics at any given stage of the race. Symonds says: 'The kinetic energy recovery is pretty fully developed and on most tracks we recover the full 2MJ/lap. However, how we use it requires a lot of work to setup an automatic system to execute the optimum strategy for a particular circuit. In applying the chosen strategy there is no one optimum tactic, it depends on battery SoC, tyres, overtaking, etc. The driver changes settings to apply tactics and may be advised by the team, which has the bigger picture. This is not too demanding on drivers, providing they have trained adequately in the simulator, and it is not really a driver differentiator.'

There is a suggestion that teams are using the unlimited MGU-H to charge the battery during cornering, when full power and maximum fuel flow rate are not required, in order to be able to increase power and hence acceleration out of a corner. It is well established that the optimum time to use the battery-to-MGU-K allowance is at the start of

a straight, in order to achieve high speed as quickly as possible. Thus the fuel allowance is traded between a time when it is not required at the maximum flow rate, to a time when full fuel flow is at the limit; however, this energy must flow via the battery, which is not particularly efficient.

F1's future

I questioned the apparent trend for Williams to use less fuel than the Mercedes, and Symonds attributed this to the Williams having less drag, but also less downforce and less overall speed. He considered that they were unable to use the lower average fuel consumption to go faster, and instead used it to start races with less fuel and less weight. The cars are just about unlimited by the race fuel limit on most tracks, but when they are the drivers practice extensively in the simulators to maximise their speed while adhering to the limit.

Mercedes has done its homework, and benefited from their performance margin in 2014 to start development early. How much others have caught up will not be clear until Mercedes unleash their full performance. The Ferrari looks good, with Sebastian Vettel obviously revelling in the car's handling, and Kimi Räikkönen looks like a driver transformed, while Renault and Red Bull stuttered at Jerez. And McLaren-Honda? The body language of their personnel did not correlate with what was happening on track and so it remains to be seen if their optimism is justified.

As for the future, I am perplexed by the assumption that 1000bhp engines, more downforce and wide tyres will automatically make the cars more spectacular and the racing more entertaining. Back in 1986, when cars had anywhere between 1200-1500bhp and sticky tyres for qualifying, allied to unstable flat bottoms and stiff suspension, they were undoubtedly spectacular. I recall Dr Harvey Postlethwaite musing that he wished the drivers would stop complaining about the handling, as, if they ever thought 1000+hp and flat bottoms would handle nicely, they must be mad.

In the intervening 30 years F1 engineers have learned, through computer simulation and control systems, to understand and take control of power output and aerodynamic characteristics, and achieve benign handling. Add to this the need to look after the tyres, if anyone thinks 1000bhp engines will lead to spinning wheels and lurid slides, they are wrong. Top speeds will be higher, as will corner speeds with all the safety implications that brings, but who can judge the speed of the cars by just by watching them from the far side of the run-off area? The dinosaurs of 30 years ago have evolved into fast, agile, and efficient cheetahs, if not quite yet into pussycats.

F1 engineering was set an enormously challenging task in 2014, and it has shown how effective it can be in solving engineering and technical problems. This should be shouted from the rooftops to attract a world that is about to realise the full implications of climate change (or not as the case may be), and not throw it all into the dustbin in order to attract elements of a fan base that has turned away from motor racing towards the siren lure of low-cost entertainment afforded by their electronic devices and on the internet. 

The limited number of tokens a powertrain manufacturer may use in 2015 – 32 – is actually no limitation on what it may change on the engine

Wireless Setup Wheel Systems

Incorporating Mantracourt T24 Radio Telemetry

- ▶ License free 2.4GHz wireless connection
- ▶ High resolution data acquisition
- ▶ Secure transmission to USB powered base station
- ▶ Display and log data direct to PC/Laptop
- ▶ Retro-fit or complete setup wheel packages available from £3,100



Novatech Measurements Ltd Tel: 01424 852744
 Fax: 01424 853002 Email: info@novatechloadcells.co.uk
www.novatechloadcells.co.uk

ABCO AUTOSPORT BEARINGS & COMPONENTS

The E-Type Liner - F1, WRC & LMP Racing

- Stiffest PTFE liner (minimal side-to-side movement, known as Deflection Under Load)
- Reduced friction under load (ball misaligns, adjusts to angles smoothly)
- Higher Radial Loads - up to 35% above alternative manufacturers
- Higher Operating Temperature: 180°C compared to 121°C for standard items
- High Angle, Narrow and Wide available in chamfered and v-stake versions
- Sizes range from 3/16 to 3/4 and Metric sizes New for 2016 - ask for further details

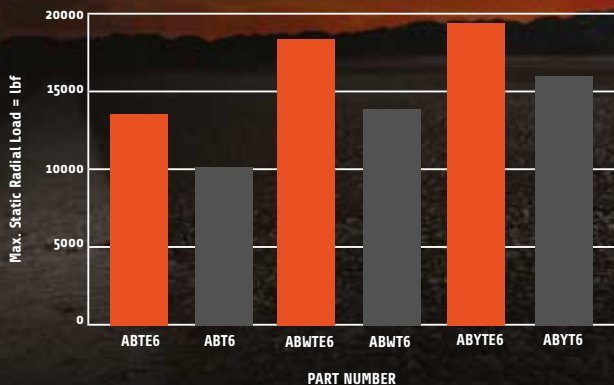

Call +44 (0) 1932 225777
 Fax +44 (0) 1932 222215
abc@autosport-bearings.co.uk

www.autosport-bearings.co.uk
 f in p YouTube

Survival of the fittest

Examining the different approaches to F1 engine design

At the time RCE went to press the 2015 power units had not been homologated and were all running in test specification, but despite this we could still glean some information about their development. Mercedes has introduced some major changes to its power unit which can be seen externally – it has dropped its ‘log’ exhaust which was thought to use Birmann style pulse converters (see RCE V25N1) to improve gas flow to the turbine and switched to a more conventional manifold design, which makes the power unit somewhat wider in the cars. The plenum is also more bulky due to the use of variable inlet trumpets, something that has created a visible bulge on the engine cover of some cars. ‘The thermal efficiency of this year’s engine is a step on from last year, and it’s all about taking that chemical potential energy, converting it into useful energy through combustion, and then not losing it through friction,’ explains Andy Cowell of Mercedes AMG HPP.

Meanwhile Renault arrived at the opening test with what was thought to be a heavily upgraded 2014 specification power unit, rather than its full 2015 design. ‘We have made some fundamental changes to gain performance and reliability,’ reveals Rob White, deputy managing director of Renaultsport F1. ‘We have upgraded every system and sub-system with items that will give the most performance prioritised. The principal changes involve the internal combustion engine, turbocharger and battery. The ICE will have a new combustion chamber, exhaust system and variable trumpets. The compressor is more efficient, while the energy recovery systems are able to deal with more severe

Honda’s return to F1, after a seven-year-hiatus, has been beset with technical glitches

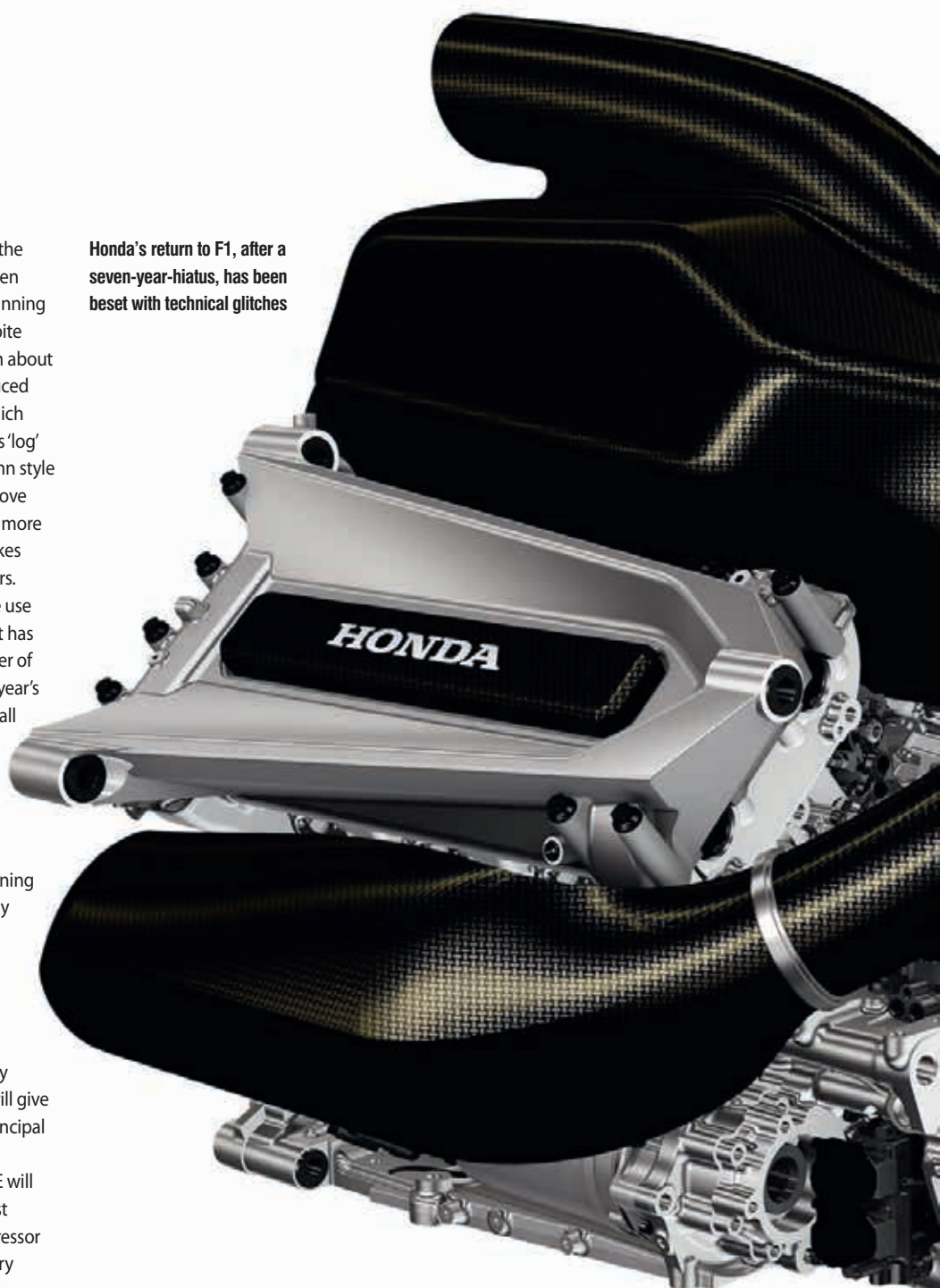

The return of the 1000bhp Formula 1 engine?

In recent months some in Formula 1 have become dissatisfied with the current rulebook. There are a number of motivations – some clearly want to break the dominance of Mercedes-Benz, while others feel that the cars themselves are not spectacular enough and the new power units are just far too expensive.

'I think things have got a bit out of kilter,' says Adrian Newey of Red Bull. 'In my opinion, Formula 1 should be a blend between the performance of the driver, the chassis and the engine,

but I think the current regulations have swung too much in favour of the engine and have given us a very restrictive set of rules in terms of the chassis. It makes it very hard for a chassis manufacturer to make enough of a difference to overcome that.'

As a result, many have called for the rules to be changed and want to see an increase of power to 1000bhp while also possibly increasing the relevance of the chassis. It seems that most F1 teams are in agreement that the power output should be increased

to 1000bhp, but few seem to agree on the best way to do it, or even when to do it (2016, 2017 or later). However, suggestions for changing the fuel flow limit or removing it all together seem to have been rejected, for now.

There are still proposals to freeze the specifications of all hybrid system components in an effort to cut costs, but again there is no agreement. However, there is apparently a consensus on changing the chassis rules to improve the look of the cars while increasing the maximum width

to 2000mm (currently 1800mm) and using wider rear tyres.

Putting the calls for 1000bhp cars into context is Andy Cowell of Mercedes-AMG HPP, who points out that it is achievable. 'The maximum power output if we get 100 per cent thermal efficiency with the current rules is 1200kW plus 115kW, so when we reach that number we have reached perfection. There is nothing stopping us getting to that number apart from a technology breakthrough, hard work and time.'

“I think Renault did a good job of developing the engine over the winter, but you don't overcome a 10 per cent deficit in a few months”

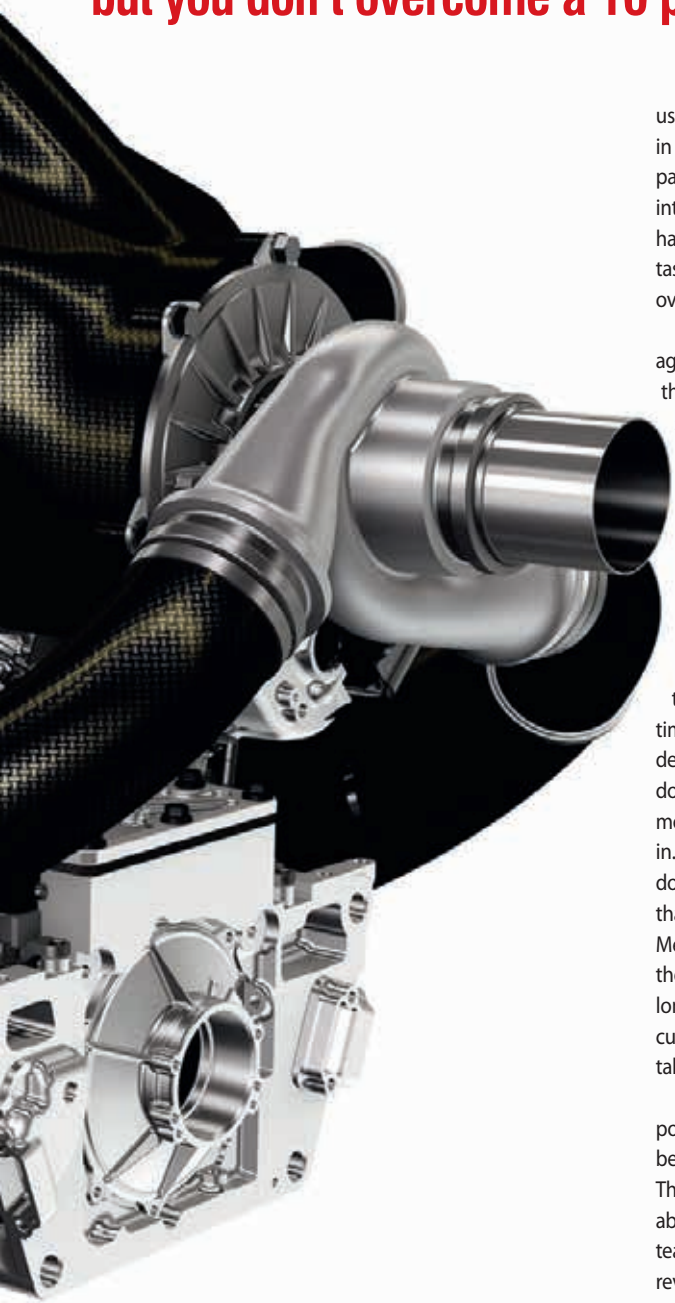

use. The 2014 unit was already well placed in its centre of gravity. We have tidied up the packaging to give greater ease of integration into the chassis. Many systems and functions have been also rationalised to further ease the task. In short, there are very few pieces carried over between the 2014 and 2015 power units.'

But at Jerez, Renault's reliability gremlins again showed their heads. A few days before the start of the test a defect in a water pump shaft was noticed on the dyno and this limited running time for the two Red Bull-branded teams. One of Renault's customers feels that there is still significant ground to made before the manufacturer catches up with Mercedes. 'Renault felt that the power deficit to Mercedes was about 10% per cent at the end of last year, and that's a big number', admits Adrian Newey. 'It is not easy to overcome a deficit like that in a very short time. I think Renault did a very good job of developing the engine over the winter, but you don't overcome a 10 per cent deficit in a few months and that is the position we are currently in. We are better than last year but we are still down on where Mercedes were last year, and that does not take into account any findings Mercedes have made over the winter. That's the nature of the engine business – it's a much longer lead time, with a slower development curve than the chassis side because the parts take so much longer to manufacture.'

Ferrari has been unusually coy about its power unit, possibly as a result of its old design being graded overweight and underpowered. The Italian firm has not disclosed many details about its development at all, however the team's technical director James Allison has revealed some information about the targets

for the 2015 design. 'Early on in the 2014 season the power delivery was not particularly sophisticated and it was quite tough for the drivers to get the type of throttle response that they wanted. It was improved a lot during the season and we have taken that a step further for the SF15-T', he explains. 'A definite weakness of last year's car was that the amount of electrical energy that we were able to recover from the turbo was not really good enough for producing competitive power levels during the race. It was one of the reasons Ferrari's qualifying performance was relatively stronger than the race performance last year. As a result we have tried to change the architecture of the engine to make it a better compromise between qualifying and racing performance. Then there is plain, simple horsepower. An enormous amount of work has gone into all aspects of our combustion efficiency to try to make sure that in this fuel-limited formula, where every team is only allowed to burn the same amount of fuel, every single compression stroke and every single ignition stroke is extracting the maximum amount of horsepower on the road.'

Honda has struggled to be able to get its RA615H power unit to run properly at all in the back of the McLaren MP4-30 and during its first two tests at Abu Dhabi (fitted to a 2014 chassis) and Jerez it failed to set a representative lap time. As a result, details about the design of the power unit are scarce, but it appears to have a Mercedes-style slit turbo charger, and may feature some innovative technology around the combustion chamber. When running, the unit creates a very different sound to the other three, although this may simply be because it was not being run at full power. 

Power struggle

As the F1 season begins we examine the power unit arms race and ask whether anybody can stop the all-conquering Mercedes team?

By SAM COLLINS

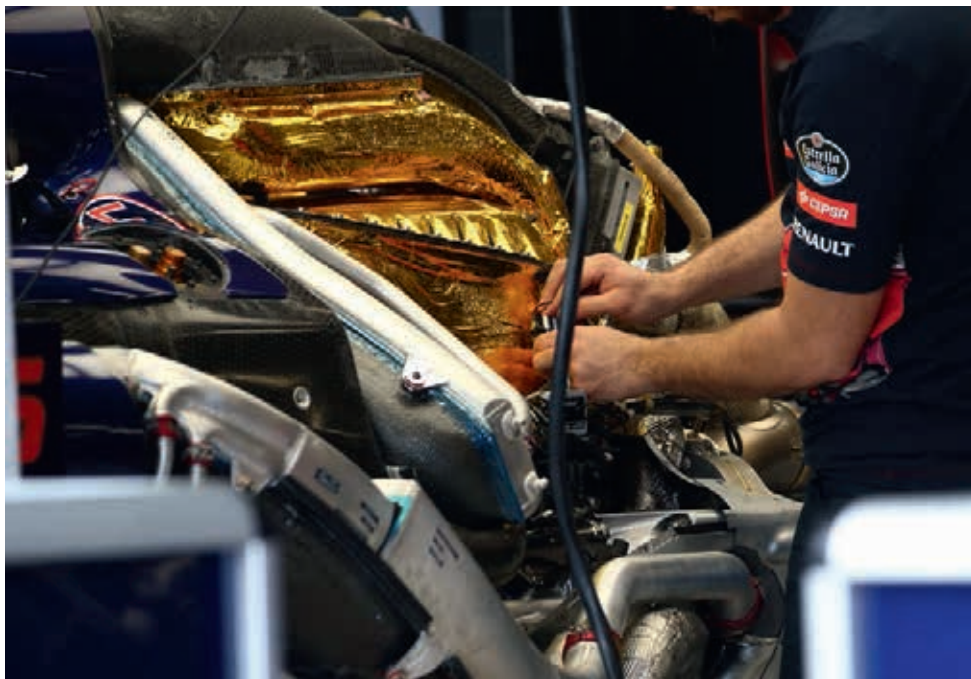

Renault's 2015 power unit has a new combustion chamber, exhaust system concept and variable trumpets



Ferrari's development programme has seen the Italian manufacturer close the gap to Mercedes

As the Formula 1 teams prepared to head out for the first competitive session of the 2015 Formula 1 season, the level of year-on-year development on the power units was revealed – all but two of the cars on the grid were fitted either with completely new or substantially updated V6 engines and hybrid systems.

Mercedes appears to have done the most development on its power unit, spending 25 of its 32 'tokens', and has gone as far as saying that its PU106B is a completely new design.

All change

The most noticeable change to the German car is the very large plenum, a by-product of the introduction of variable intake trumpets. It is so big that it causes a noticeable bulge on the engine covers of all the cars using it – Lotus, Williams, Force India and the works team. Another major change is the apparent abandonment of the Birmann-style gas dynamic rectifiers in favour of a more conventional set of exhaust headers, likely using the Sulzer type rectifiers instead. Mercedes remains tight lipped on the reasons for this change. Looking at the air ducting arrangement and filter location, it appears that the V6 engine has retained its split turbocharger concept with the compressor mounted at the front of the block, the MGU-H nestled in the V of the engine and the turbine mounted at the rear. Once again the Mercedes appears to be the class of the field and the brand still has enough tokens to make another significant step during the season, probably around the time of the Japanese Grand Prix. These seven tokens could, in essence, be combined with the 25 allocated for use ahead of the 2016 season to give Mercedes the capability to make another significant step forward.

Ferrari has also made major changes to its power unit. The 2014 design was deliberately compromised in order to help the aerodynamic department get the best out of the car but the potential benefits of reducing the overall volume of the power unit were never quite realised. It was apparent that the Ferrari unit was overweight and underpowered, and most of the updates have been to rectify this.

'Early on in the 2014 season the power delivery was not particularly sophisticated

'Mercedes has a good car, a good engine and very two good drivers, but the problem is that the gap is so big that you end up with three-tier racing'

and quite tough for the drivers to get the type of throttle response that they wanted. It was improved a lot during the season and we take that a step further for the SF15-T,' technical director James Allison explains. 'A definite weakness of last year's car was that the amount of electrical energy that we were able to recover from the turbo was not really good enough for producing competitive power levels during the race. It was one of the reasons Ferrari's qualifying performance was relatively better than race performance last year. As a result we have tried to change the architecture of the engine to make it a better compromise between qualifying and racing performance. In this fuel-limited formula an enormous amount of work has gone into all aspects of our combustion efficiency to try to make sure that every single stroke of the engine is extracting the maximum amount of horsepower on the road.'

To achieve these goals, Ferrari has used 22 tokens, with the remainder likely to be deployed ahead of the Belgian or Italian Grand Prix. It is clear to see that the Italian power unit has adopted a totally different exhaust concept – in 2014 it ran its three-into-one exhaust header up the side of the V6 engine and over the top of the bell housing to the turbine. On the 2015 design its headers appear to be larger in diameter and run much lower in the car routing to the turbine via holes in the side of the bell housing. Curiously the plenum on the Ferrari V6 appears no larger than that of the old power unit found in the Marussia, raising the possibility that it is yet to feature a variable inlet.

Following the Australian Grand Prix, Renault looked to be facing another tough F1 season. However, having used the least tokens of any of the manufacturers, 20, it appears that there are still significant upgrades in the pipeline. Renault claimed at the start of the season that it had introduced a new combustion chamber, compressor, energy store, water pump and variable inlet trumpets. But the teams using the Renault, Red Bull and Toro Rosso, have both complained that the updated power unit is still bugged by both reliability and usability issues, stating that the power is not evenly distributed and reduces the cars overall drivability.

'The main difficulty is the operating modes of the engine and the new power unit is more difficult to configure than last year. However, when it comes to power, we have made a step forward compared to 2014, Renault's head of operations, Remi Taffin, admits. 'We are still behind in terms of performance and reliability, but Renault has won championships before without having the most powerful engine.'

Finally Honda, which returned to Formula 1



Honda suffered a troublesome return to F1 – the power unit was plagued with reliability issues and was five seconds off the pace

in Australia, had a torrid time with its RA615H power unit proving to be a long way off the pace. Indeed, it has been suggested that the Japanese marque detuned the unit just to be able to finish the race, yet one of its V6 engine's still suffered a catastrophic failure on the way to the grid, leaving only a single McLaren in the race. As a result little can be revealed about its performance potential other than that it appears to be very compact.

Honda has been given nine tokens to use during the season, but it is likely to make a substantial number of reliability upgrades before they come into play.

Mind the gap

The clear different performance levels of the power units have led to some, notably Christian Horner of Red Bull, to call for some kind of performance balancing to be employed. 'Mercedes has a good car, a good engine and they've got two very good drivers, but the problem is that the gap is so big that you end up with three-tier racing and that's not healthy for F1. The FIA has an equalisation mechanism in its rules and I think perhaps it's something that needs to be looked at,' the Red Bull boss urged. 'The FIA has a torque sensor on every engine, a power output that they can see, that every engine is producing. They have the facts and they could quite easily come up with a way of finding some form of equalisation.'

Bernie Ecclestone later supported Horner's claims and pointed out that indeed there is a mechanism which could be used to blunt



Mercedes has already used more engine tokens than anybody else, leaving it with the least scope to develop its power unit

the three pointed star somewhat. 'There is a rule that in the event that a particular team or engine supplier did something magic – which Mercedes have done – the FIA can level up things,' the FOM boss explains. 'Mercedes has done a first class job but we need to change things a little bit now and try and level things up somewhat. What we should have done was frozen the Mercedes engine and leave everybody else to do what they want so they could have caught up,' he says. 'We should support the FIA to make changes.'

But Mercedes motorsport boss Toto Wolff dismissed the calls for equalisation, telling Horner and Red Bull to 'get your head down, work hard and try to sort it out.' With Ferrari siding with Mercedes it seems that equalisation is unlikely to happen.



Motive force

Improving on its dominant 2014 power unit was a big challenge for Mercedes but with its PU106B it did just this. The question is; how do you make a great engine even greater?

By SAM COLLINS



Mercedes AMG HPP could quite easily have been satisfied with what it had achieved by the end of the 2014 F1 season. In qualifying its product had been on pole position for every single race, and it had powered cars to 16 race victories and both world titles. But while the results were good, the staff at the factory in Brixworth were not entirely happy; and they wanted to build something better for 2015.

'As a company we have two missions on our intranet homepage which we see every time we login to our computers,' says Andy Cowell, managing director, Mercedes AMG High Performance Powertrains. They are to win the Formula 1 world championship, and have zero category one failures at the circuit. We did not have a perfect 2014 season and only achieved one of the two aims.

'There were some issues that were causing us

pain at race weekends; in Canada, in Hungary and even the last race in Abu Dhabi, a coolant pump problem caused issues for Nico [Rosberg]. These issues were not things which could be resolved by little bits of chamfer change or radius change, it was much more. While any failure is an opportunity to learn, that is the very thin silver lining on a big dark cloud. We had to stop and think; how would we look at the concept to make it more robust?'



Improving reliability became a main aim for 2015, then. But Cowell says there were two other areas of focus for the engineers at HPP. 'We had three main aims, reliability I have mentioned, but another was to do with a change in the regulations. The rules dropped us to four power units from five per driver, with an extra race added to the schedule, potentially, so our internal durability target had to go up by a big chunk as we don't like grid penalties.'

The final focus for 2015 was perhaps the most obvious; to make the works Mercedes F1 car faster. But this is of course not a pure power unit development task and it relies on a very close working relationship with the Mercedes AMG F1 team based in Brackley near Silverstone. In fact, it is fair to say that the PU106B was designed around the Mercedes AMG F1 W06 Hybrid which, itself, was designed around the PU106B. 'The third objective

is the most important, and it is in the title of the business; Performance. We have been working hard on all areas of the power unit to increase the conversion efficiency of every single system – trying to make our package more thermally efficient and produce greater absolute power. The focus in this respect has been on combustion efficiency and frictional losses – be they in core parts of the ICE or the ancillary aspects of both ICE and ERS.

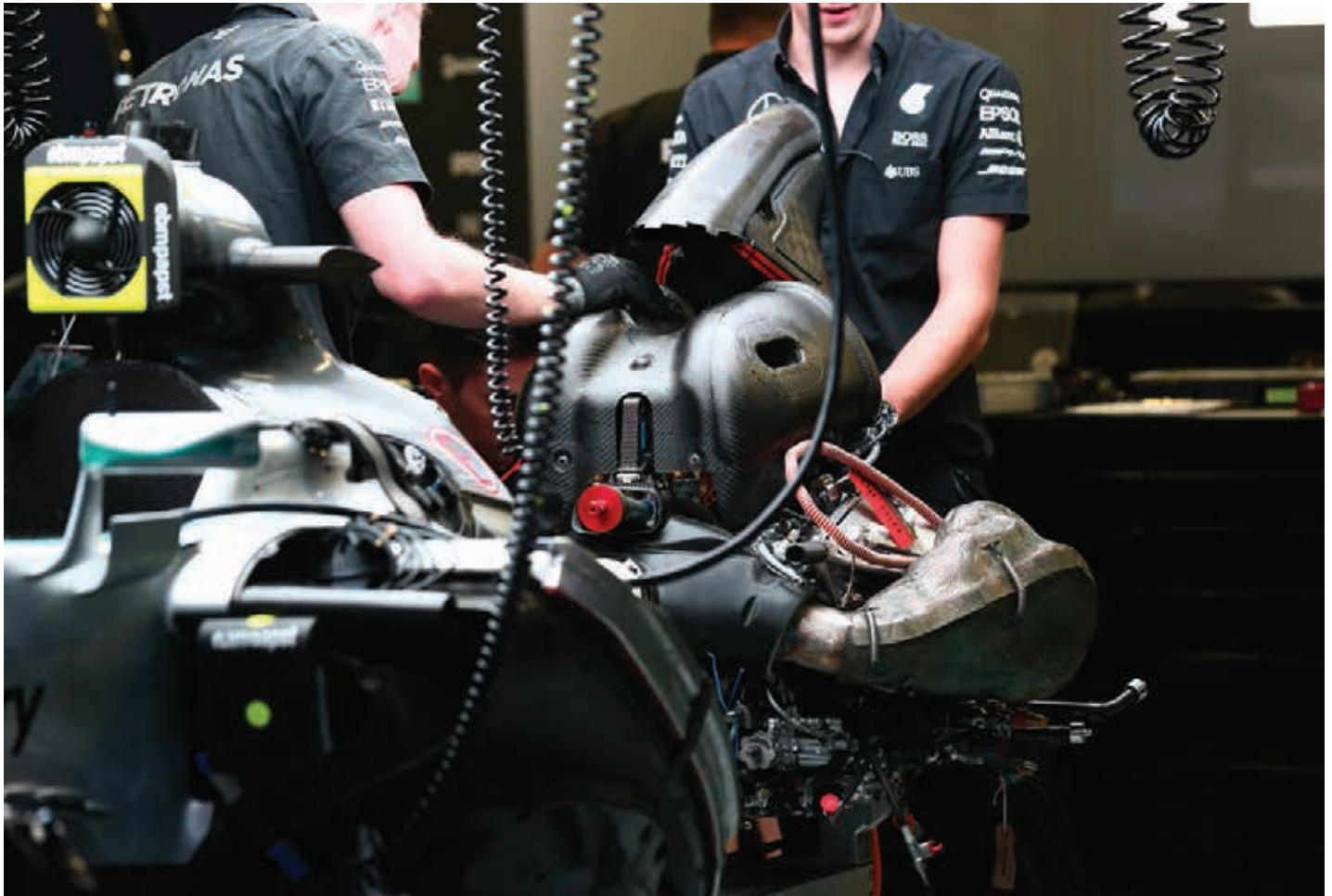

The Mercedes PU106B. Note the exhaust routing (the engine is actually the wrong way round in this picture) and the large plenum which is a result of using a variable inlet system

On top of that there is energy flow efficiency and utilisation so we're not distracting the guys setting up the cars and the drivers driving them.'

Ahead of the 2014 season, the engineers at Brixworth were working in unfamiliar territory with the new technical regulations and the company's first ever turbocharged engine. For 2015 they had a starting point, and unsurprisingly the PU106B is mechanically very similar to the PU106A. Both are 1.6-litre V6 engines using direct injection and a single turbocharger. This internal combustion engine is mated to a pair of motor generator units, one used for kinetic energy recovery and the other for exhaust energy recovery – this is all defined by the technical regulations. The 2015 power unit has many features and concepts from the 2014 version including the distinctive split turbocharger layout: 'It's very much a case of evolution rather than revolution in 2015. Where

last year was a case of "can we do it?" We are now faced with a different challenge – "How do we improve it?" Cowell said at the roll out of the W06 in Jerez, Spain. Yet he then went on to claim that the PU106B was an all new power unit, distinct from the PU106A.

New or upgraded?

Initially this was thought to be a bit of bravado as, under the F1 regulations, no more than 32 'development tokens' could be used to update the power units year on year. This equates to around 48 per cent of the total power unit so it seemed that an 'all new' power unit would be impossible. But Cowell went on to point out that you can also change parts for reliability reasons without using up any tokens, and with fewer units available per driver and maybe more races almost anything could be changed for reliability!

'I think we probably carried over the odd stud and a few washers but that was about it,' Cowell says. 'It was a big programme, not just a project. Because of the number of tokens that we thought we had, it provided a very broad opportunity. We did not do any filtering based on return per token spent. It was a case of everything can be in. Because '14 was not silky smooth in terms of reliability, and because of that step up in terms of usage, many parts that met durability targets in '14 had to be reworked. We decided that we wanted to be chasing it all.

It was very tough because of that, there was perhaps less than five per cent carry over.'

At the heart of the power unit is the cylinder block which is a fully stressed component in modern F1 cars. On the PU106B, essentially every detail of it has been studied and re-optimised compared to that of the PU106A. Both share common design features which are defined in the regulations, such as the mounting points for the chassis and transmission, and a general concept in terms of layout.

'It carries a tremendous amount of load,' Cowell says. 'There is a real challenge just keeping the cylinder head on top of the crankcase as you increase the performance and the pressure during the combustion process. The head wants to come off. That is reacted by studs down into the crankcase, so you have the challenge of sealing those gasses in across the joint face, the challenge of making sure the load goes down into the heart of the crankcase and ensuring that the crankshaft does not come out of the bottom of it all. On top of that, the crankcase is the part that ensures the stiffness of the rear of the car, so it also has these big structural loads going through it. As if that was not enough, you have to then consider that it is a huge mounting bracket. There are probably close to 100 bosses holding ancillaries on to the side of it; gear hubs, hydraulic systems, and for all of those bits you would rather use a smaller

It is fair to say that the PU106B was designed around the W06, which itself was designed around the PU106B



Another shot of the 2015 power unit. Again this is the wrong way round, but it's clear from this that the exhaust is much larger than the 2014 Birmann log design. Rod Nelson at Williams (a Mercedes HPP customer) says this increased volume is aerodynamically neutral

fastener than a larger one, which increases the risk of a fatigue failure, or that a thread will pull out'. All of which highlights just how many areas of the design needed to be reworked to cope with what may seem like a relatively innocuous increase in engine life. 'This year there are crankcases that have done lots of mileage. Sergio Perez has used one for seven race events and that went on and did several Fridays. That highly loaded bracket has a tough life,' Cowell adds.

To a generalist, the idea of increasing component life in this way would simply mean adding material to critical areas and generally beefing up the component. This would, one can safely assume, add weight, but in Formula 1 the power unit is built to a minimum weight and with restrictions on whole car weight distribution, an overweight power unit can be a major weakness.

'The weight limit is 145kg minimum, we all strive to be just a few grams above that. But to deal with more load you would typically put more material in to deal with local stress, or use a better material or some crafty design and shapes. You are constantly looking at areas which are okay and whittling them down, then looking at areas which are not okay and increasing them,' Cowell explains.

'Of course, after a year's worth of racing we had lots of examples, and a year of experience. We also had another year's worth of engineering

analysis and that led to a more refined model. We have put a huge amount of effort into the optimisation of the stresses and the distortion from the loads without compromising performance, and all of that in harmony. We are fortunate that we are all on the same site and eat in the same canteen, it just helps with all the iterations and the development. I guess that the real focus is that it is one business with one ambition,' Cowell says.

Regulatory limits

The technical regulations for Formula 1 power units could be seen as very restrictive as they define many areas of the power unit in great detail; including the cubic capacity, number of cylinders, cylinder bank angle, minimum centre of gravity height, crankshaft centre line height and even the cylinder bore. But Cowell does not believe that he is restricted too much by the current rules. 'I don't think the regulatory limits drive us to make sub-optimal decisions in general design terms. The deck height is free, for example, the bore size is fixed at 80mm, so we have not done any work on anything else, so I don't know if we are restricted there or not. I think 80mm was a number everyone was happy with,' he says.

One major design element to carry over, as mentioned earlier, is the split turbocharger concept seen on the PU106A. It features the compressor at the front of the engine and the

turbine at the rear. The two are linked by a common shaft shared with the MGU-H. It is a concept rumoured to have been inspired by the Rolls Royce Pegasus jet engine but Cowell denies that this is the origin of the idea. 'I have heard that story doing the rounds but it's not true. There is a bit of paper we have with the full list of turbocharger options which we could think of to use. Each one has the pros and cons for each solution, and where else the concept has been used. With this solution there was nothing against it for where it was used.'

But the split turbocharger itself seems not to have been the biggest challenge in creating this layout. Nor, according to Cowell, is the MGU-H. Instead, as has been suggested in these pages in the past, the real secret is actually to do with how they are all connected.

'I think the MGU, compressor and turbine are not a big challenge, but what lies between them is a monster challenge,' Cowell admits. 'The

'I think the MGU, compressor and turbine are not a big challenge but what lies between them is a monster challenge'

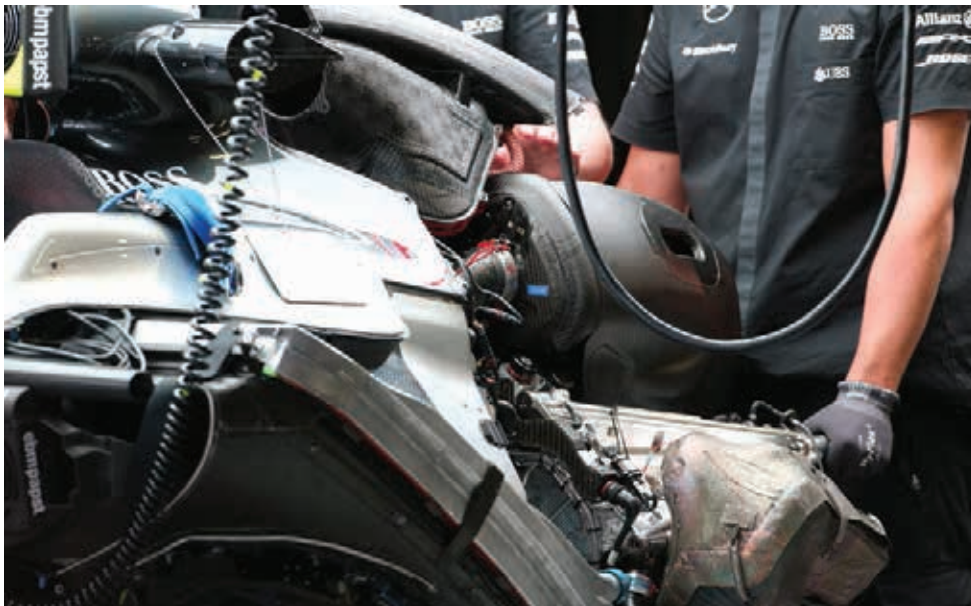

PU106A in the W05. While there are many carry over features on the 2015 unit, there are also some new concepts in use

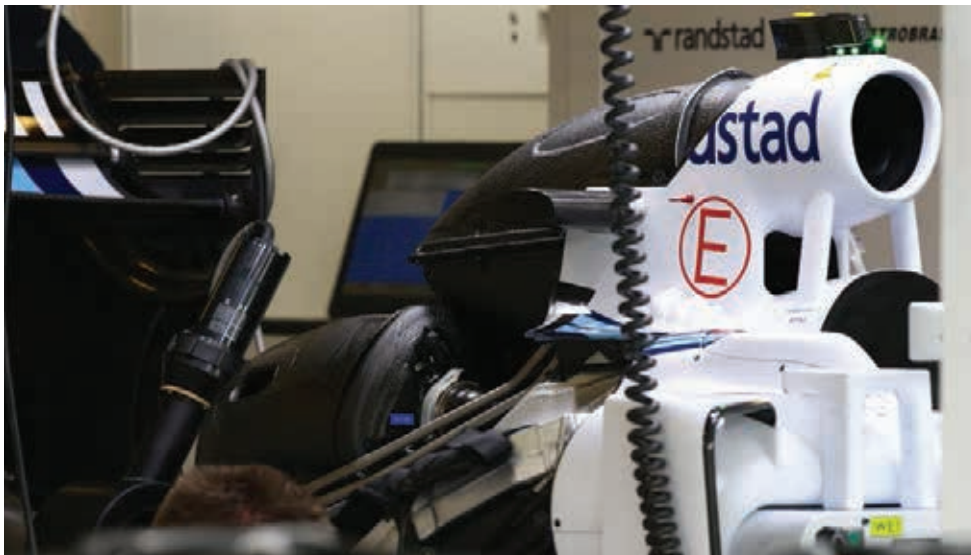

The Williams FW37 has used the PU106B to great effect this year combining its slippery aero package with the Merc grunt

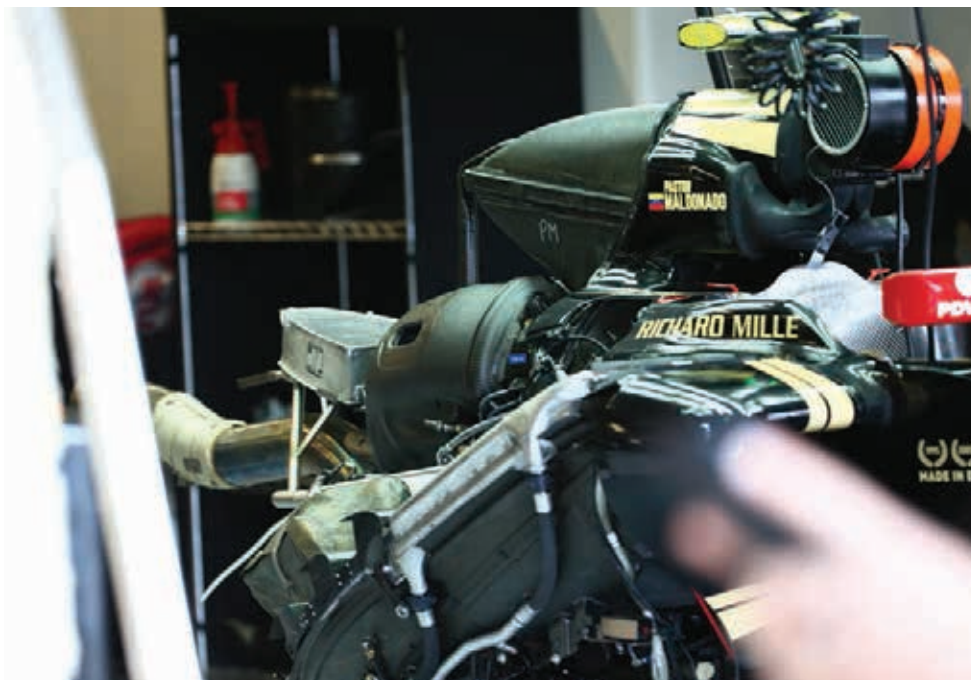

Installation of PU106B in Lotus E23. Next year it's likely that the Enstone team will revert to Renault power as works team

MGU is just an electric motor in essence. The power level is not prescribed in the rules, so the first problem is to understand what the desired power characteristic of the machine is in terms of torque and RPM. There you are balancing the two jobs it does, harvesting the energy from the turbine, and the second one is speed control of the overall shaft, and that is where you need to think about the drivability of the power unit, as it is controlling the compressor load into the engine, so there is that, too. Once you have that target and the 125,000rpm limit then you have some T-junctions to consider over which design route to take.'

Cowell, quite understandably, refused to elaborate further, indeed the design and installation of MGU-Hs remains something that all power unit engineers in the Formula 1 paddock are reluctant to speak about.

But not all of the designs on the PU106B are optimised versions of the concepts used on the PU106A, in some key and very obvious areas there are new concepts in use in 2015.

New concepts

The 2015 design features a variable inlet system on the combustion engine, something which had not been permitted under the 2014 rules. 'We all decided not to do it in 2014 because we wanted the introduction of these new power units to be simpler, but some manufacturers were very keen to have the variable inlet from 2015 onwards. It allows us to keep the optimum tuned length of inlet while the RPM varies. We do have a variable inlet, and we do get an efficiency improvement because of it, we spent tokens on it, and it is fair to say that the car goes quicker because of it,' Cowell says.

Using the variable inlet system not only increases the complexity of the power unit but it also raises its centre of gravity and leads to a substantially larger plenum. 'Its got to earn its keep because of the implications of using it. Any system adds complexity and that increases the risk of not finishing a race. Any system adds mass and volume, and introducing such a system requires you to spend some resource, that's cash out of your budget and people out of your pool. It means you have to balance benefit and risk. For us, we put some good thinking into its design and it is a relatively simple layout which yields decent results. In terms of design it is a work of art, the engineering elegance is exceptional,' Cowell enthuses.

Another change immediately apparent from the first day that a car using the PU106B ran in public was that the innovative Birman exhaust layout used on the PU106A had been dropped in favour of the larger and more conventional Sulzer style of exhaust header. The 2014 concept was all about getting the best gas flow to the turbine face which allows the MGU-H to recover more energy, but it's been suggested that this approach also saps power from the ICE. Cowell won't be drawn on the specifics but

points out that: 'you don't make a change like that unless you make the racecar quicker, so we obviously feel that this layout makes the car quicker. On this engine the pipes are longer, so the mass is probably greater, the volume is larger and therefore the power needs to be greater to overcome those things. With all three of those things there is also another full year of development in terms of the power aspect, the aerodynamic impact of having a blockage in the sidepod; you can do work to minimise the impact of that blockage and you can do work to minimise the mass of longer primaries.'

Aiming for the stars

Perhaps the reason for this change can be explained by Cowell's ultimate target, total combustion efficiency. 'We would love to convert all of the chemical energy from the fuel into pressure on the piston, which would give us 1240kW in to the crankshaft, then you would have no energy going down the exhaust pipe. If you aim for the stars you might just clear the trees. But the combustion chamber is the best place to do the conversion. The PU106B is perhaps the most efficient motorsport power unit ever. The exact number will probably not be known for many years but Cowell says, 'We are achieving over 40 per cent efficiency, but under 50 per cent. We are lot better than last year and the figure is phenomenal!'

Lift and coast

But this constant quest for greater efficiency has been largely misunderstood and criticised by the mass media, especially those on television who can no longer simply say: 'More power is better'. It has obviously been noted, as Cowell is keen to stress the importance of building a more efficient power unit. 'I think overall everyone does a bit of lift and coast, which is what they did in the V8 era because everyone wants a lighter car at the start. Everyone knows that the lap time penalty of a little bit of lift and coast through the race is a small penalty to pay for being lighter at the start and being able to make up places. It's worked out remarkably well. I think there are a third of the races where we can run flat out and not worry about the fuel allowance, there is the other third, where we have to think about it a little bit but not too much, and then there is the final third where it's a bit more challenging and it adds to things; but those races tend to have it negated by a safety car. But there are perhaps two or three races a year where lift and coast is a pain, but for others it is an opportunity', Cowell explains.

'For the power unit manufacturers we are all chasing a good conversion efficiency and that is what is going on in the transport sector across the board. It's even happening in our homes, we want our house to be a certain temperature and we are not willing to compromise on that, but we want less energy going in so it is all the same game really.'

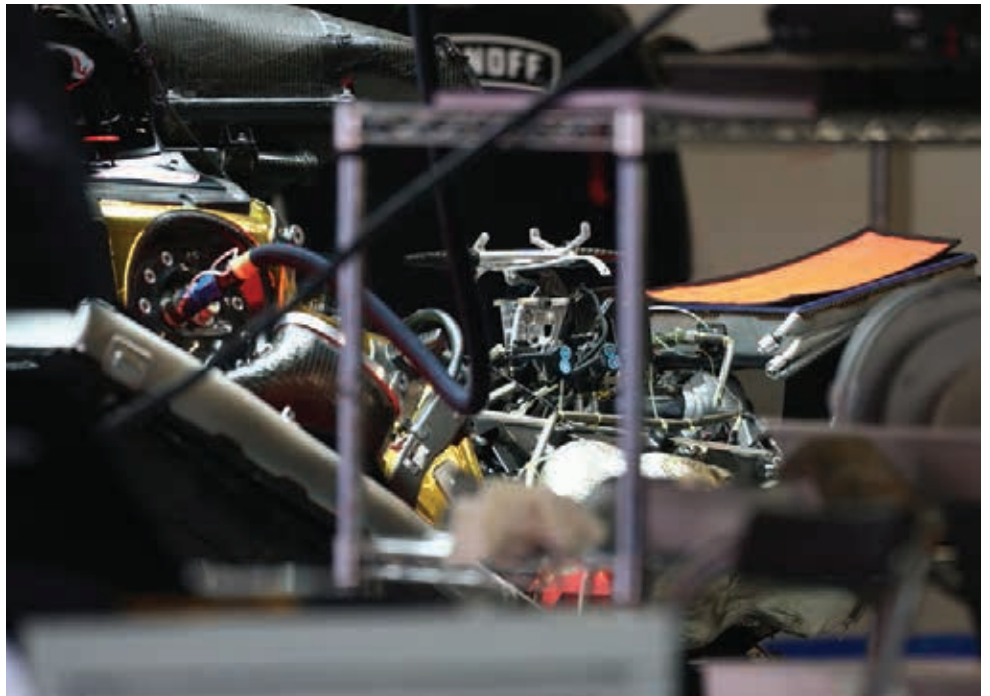

The variable inlet system (or at least the best picture of it that's available). According to Andy Cowell it is simple and elegant



PU106B exhaust system features longer primaries, increasing the size and mass of the design but also the power output



The 2014 power unit in the Mercedes W05 – the much smaller plenum is clear in this pic, as is the smaller exhaust header

With the efficiency increase confirmed by the engineers and their test equipment at Brixworth, thoughts turned to production schedules and early ideas for 2016. Once the work on the 2015 unit had been signed off and homologated, the power units would be frozen in specification for the entire season. But then, as the festive season approached in 2014, it was announced that manufacturers would be allowed to develop the power units during the 2015 race season after all.

Christmas present

'That was my Christmas present from Charlie [Whiting] last year,' Cowell says. 'I was actually right in the middle of my Christmas shopping when I received the news. It did not have any impact on us to start off with. We already had a very clear target for how we wanted to get to Melbourne, and we were heading toward 25 tokens usage, and driving for increased reliability and performance as planned. After about a 30 minute study of what the change meant and a bit of a think, we quickly decided that we would not do anything differently, we just stuck to our plan.'

But as the season developed it was clear that the engineers at Brixworth would have to do something with their remaining seven tokens, they were just not too sure what; and indeed not too sure how. 'After the first couple of races we stepped back and had a think about what to do. We simply were not set up for doing in season development like that,' Cowell admits. 'Our business was set up to innovate 365 days

a year but only introduce one new product annually, for the first race of each season. We asked around "what are we going to do guys? Is there anything performance related left on the table?" But the answer was no, it was all on the power unit already. So we then had to look at what we are working on for 2016 that could be accelerated into this year. It was a major headache for the programme management people. How do you introduce these updates? Indeed, how do you track test it when you have no track testing? We just didn't know.'

Eventually an update package was decided on and it was calculated that Monza would be the best place to introduce it. Apparently it consisted of a new combustion chamber (including piston crown) and some associated components. Additionally, Petronas introduced a new fuel in conjunction with the update (and later introduced new lubricants at the US GP).

But the introduction of the updated power unit did not go as smoothly as the team had hoped. Water contaminated the lubrication system on Rosberg's car, and that left the team with a difficult set of options. 'We were pushing like hell for an in-season update, but we feel it was quite brave to bring in some 2016 development on the third and fourth power units for the works cars. But on Saturday morning at Monza we had some contamination and we didn't know what to roll back to. Eventually we opted to roll back to an old unit, we knew it was a risk. But we decided to race like hell because we like finishing right at the top,' Cowell says. The power unit, which

had been fitted to the Rosberg car, had already reached the end of its planned life and was being used on one of the toughest tracks for engines of the year. Fighting to get second position when third was already secure, the team adopted a more aggressive strategy, and eventually a piston failed and the car retired shortly before the end of the race.

While the Mercedes team supported the move to run the power unit as hard as possible – 'We are racers, you have to try,' explained Mercedes technical director Paddy Lowe of the choice to push – seeing a Silver Arrow fail on track still grates with Cowell. But, overall, it seems that the Mercedes AMG HPP team feels more satisfied with its performance in 2015 than it did in 2014, although it should be noted that 'more satisfied' is certainly not the same thing as 'satisfied'.

'We have done considerably better than last year in terms of reliability, but there have been some issues. There was a broken crankshaft on one of the Force Indias, for example. There have been a few other smaller issues too,' Cowell highlights candidly. 'The amount of effort to deliver a good race weekend is still too high, so we are looking at that.'

Future classics

But work now at Brixworth is all about the 2016 and even the 2017 power units, which are reported to once again be an improvement on their predecessors. With stable rules, and a reduced token allowance, the 2016 unit is expected to be closer to the PU106A than that was to the PU106A, but it of course will not be exactly the same. The turbocharger, for example, will look different as a rule change aimed at giving the cars a better exhaust note will see installation differences. 'The new rule on wastegates is really a routing issue. It does not help crank power at all, but it does improve the quality of the sound,' Cowell explains. Looking forward to the 2016 power unit in general terms the aims have already been set, and as well as winning the championship and not failing in a single race, Cowell reveals that 'the durability requirement is the same in 2016 that it was in 2015, so that is not a big aim, but we are working on improving the serviceability of the power unit; then it's a programme to increase the efficiency of everything.'

In increasing efficiency and edging closer to 50 per cent perhaps Cowell and his team are doing more than just clearing the trees, but with rules stability, rivals such as Ferrari are rapidly closing the gap to the three pointed star. So perhaps the dominance of the PU106B may not be repeated for some years – but then, that is what was said about the PU106A. 

'Our business was set up to innovate 365 days a year but to only introduce one new product annually, for the first race of each season'

What's the **secret** about the new 911 GT3 Cup's **new brakes?**



It's Quicker.™



OFFICIAL PARTNER

PORSCHE
MOTORSPORT

PFC
BREMSE



‘We started with last year’s power unit as a basis, but we developed it into a much better product’

Ferrari staged a special launch event for its new Formula 1 power unit, the 059/3, in late 2013. It was the first new F1 engine from the famous Italian constructor since 2006, so perhaps it was not surprising that its arrival was met with such fanfare. At the launch the bare V6 engine was shown lacking exhausts, turbo, hybrid system and many other parts, but once the power unit was fitted to a car, initially a one-off GT car test

bed and later the 2014 Ferrari, Marussia and Sauber chassis, it took on a very different appearance.

The exhaust manifolds took a tight route curving upwards around the cylinder head in a three-into-one layout on each bank of the engine with a curiously large wastegate sat above the turbocharger. The turbo itself did cause some consternation when it first appeared as it did not feature a separate ballistic cover like that of the

Mercedes and Renault, rather it was built into the main turbo housing instead. Overall the concept of the Ferrari 059/3 was clearly heavily influenced by the demands of other departments and Ferrari technical director James Allison admitted as much at the roll out of the 2014 Ferrari: ‘Our engine department have been aggressive and bent over backwards for us on the chassis side to produce an engine that can be packaged tightly and can

Prancing horsepower

The 2015 version of Ferrari's V6 power unit has shown itself to be a great improvement over its predecessor. *Racecar* uncovers some of the secrets of its success

By SAM COLLINS

be cooled with radiators that are not too big. Our car has quite a neat bodywork package and the radiators are quite small and that is a result of what the engine guys have done. The engines are incredibly busy compared to the V8s, and the Ferrari has been rather exquisitely packaged.

Its tight packaging came as the result of a few unconventional design decisions: the charge air cooler was mounted in the V of the engine, and the

oil tank was mounted in the transmission rather than in the more conventional location at the front of the block. The MGU-K was also mounted at the rear of the block.

In races, the Ferrari 059/3 seemed to be a reliable unit but it was also said to be overweight and underpowered and the Italian manufacturer reacted with not a little aggression. The head of the engine programme Luca Marmorini was forced out, as were

two team principals. A new focus was placed on improving the power unit for 2015, and from the very first test at Jerez it had clearly paid off.

'The power unit has, along with the rest of the car, been an area of extremely high effort to improve,' Allison says. 'We had a number of issues with last year's engine and power unit. Early on in the season the power delivery was not particularly sophisticated, and it was quite tough for the drivers

to get the type of throttle response that they wanted. It was improved a lot during the season and we take that a step further this year.'

The hybrid system was also highlighted as a weakness by Allison and was another area that was fundamentally revised for 2015. 'The amount of electrical energy that we were able to recover from the turbo was not really good enough for producing competitive power levels during the race. That's one of the reasons why Ferrari's qualifying performance was relatively strong compared with the race performance last year. That's an area where we've tried to change the architecture of the engine to make it a better compromise between qualifying and racing performance,' he says.

'Then, there is plain simple horsepower. A tremendous amount of work has gone into all aspects of our combustion efficiency to try and make sure that in this fuel limited formula, where every team is only allowed to burn the same amount of fuel, that every single compression stroke, every single ignition stroke, is extracting the maximum amount of horsepower and putting it on the road.'

New power unit

While not stated by any Ferrari engineers, it seems that the compromises made on the power unit to favour the chassis and aerodynamic demands went too far. But Ferrari was clearly minded to move away from the concept in 2015. The new power unit (PU) did not have the big launch of the 2014 variant and only a subtle name change. But the Ferrari 059/4 was a very different machine, according to Luigi Fraboni, Ferrari's head of engine operations. 'We started with last year's power unit as a basis, but we developed it to a much better product, but we realised that there were others better than us so we reworked everything. A big effort went into combustion, we looked at the turbo, getting the most out of the energy recovery and we did a lot on the oil system. We looked at better knock control too, and we had to get better correlation between the software and how the engine worked in reality. In the end, we ended up with basically what is a completely new engine.'

The 059/4 saw a number of visually obvious changes, most notably an all new exhaust layout with the manifolds now running low along the flanks of the engine block to the twin entry turbine, which now appears to be mounted in a lower position in the bellhousing. Returning to convention the oil tank appears at the front face of the block in common with the layouts used by other PU manufacturers.

However, it is the changes that cannot be seen from the outside that seem to have brought the biggest impact on performance, especially in terms of combustion. The work here is not just limited to the shape of the piston crown and combustion chamber itself but has seen Ferrari rely on two long term

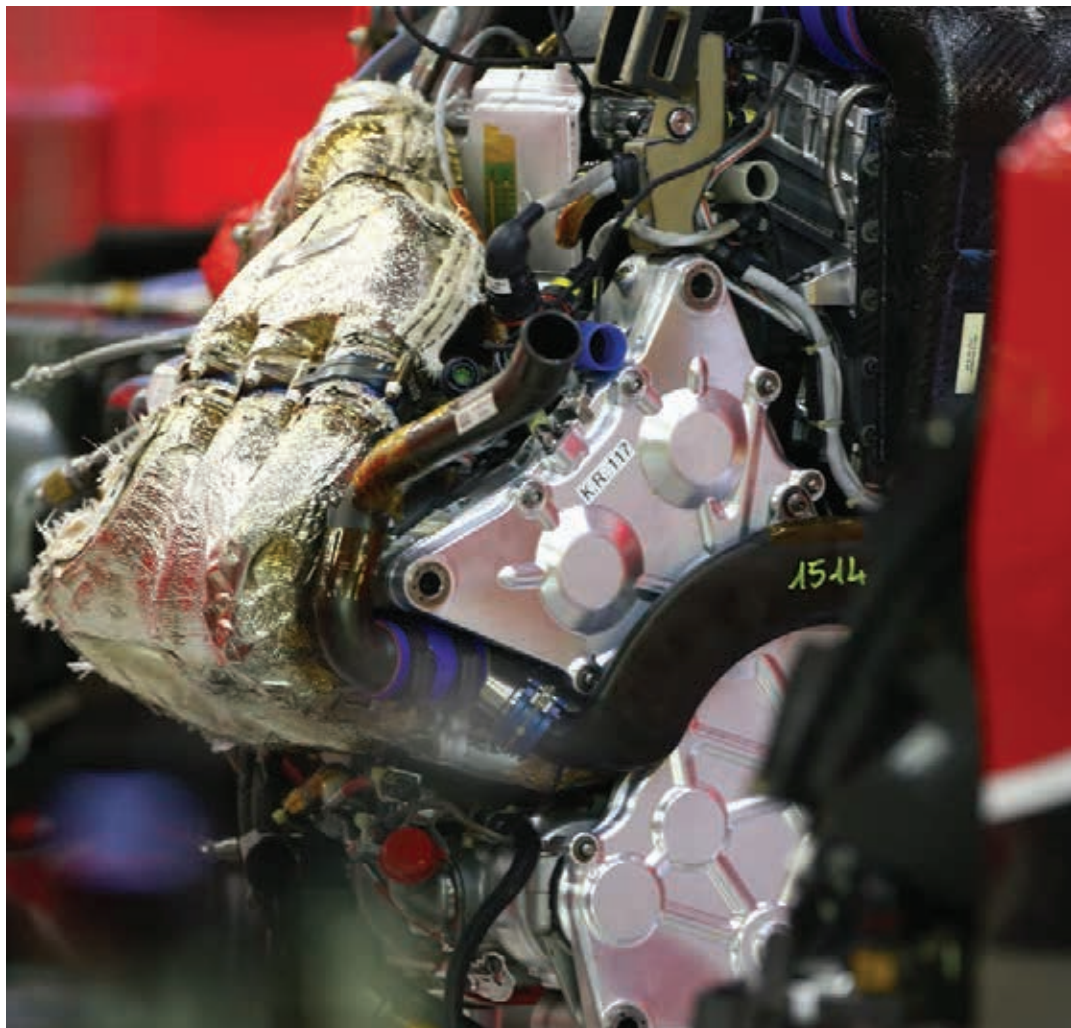

Top: 2014 power unit (the 059/3). Picture shows the exhausts swathed in thermal protection, something that Ferrari did not do for much of the season, baffling many as this meant it lost heat which reduced the recoverable energy of the MGU-H
Above: Another shot of the 2014 unit; the intake and charge cooler in the V of the block can be seen here. A feature of last year's engine was the tight path taken by the exhaust manifolds, curling upwards into a three-into-one layout on each bank

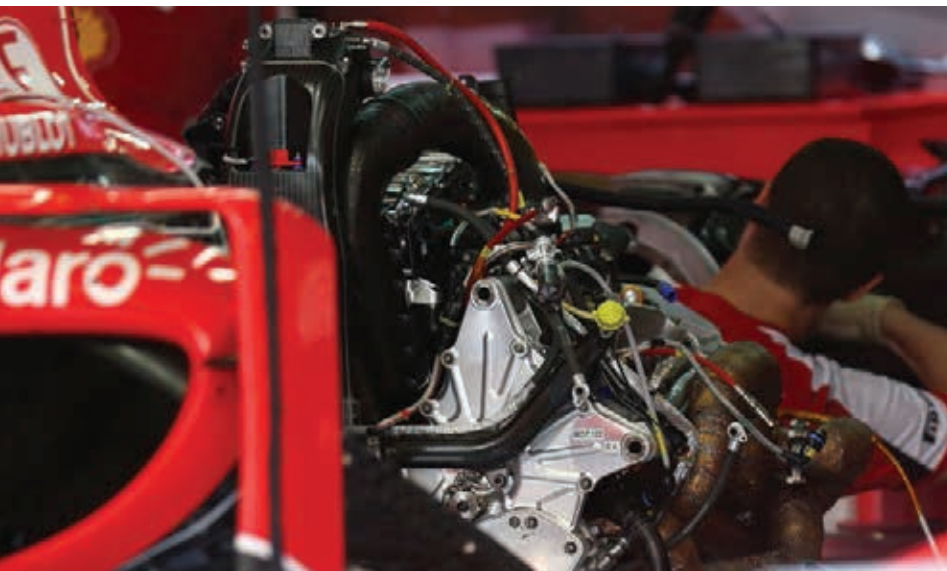

The 2015 power unit (059/4) has a relocated oil tank, now mounted at the front of the block as per convention

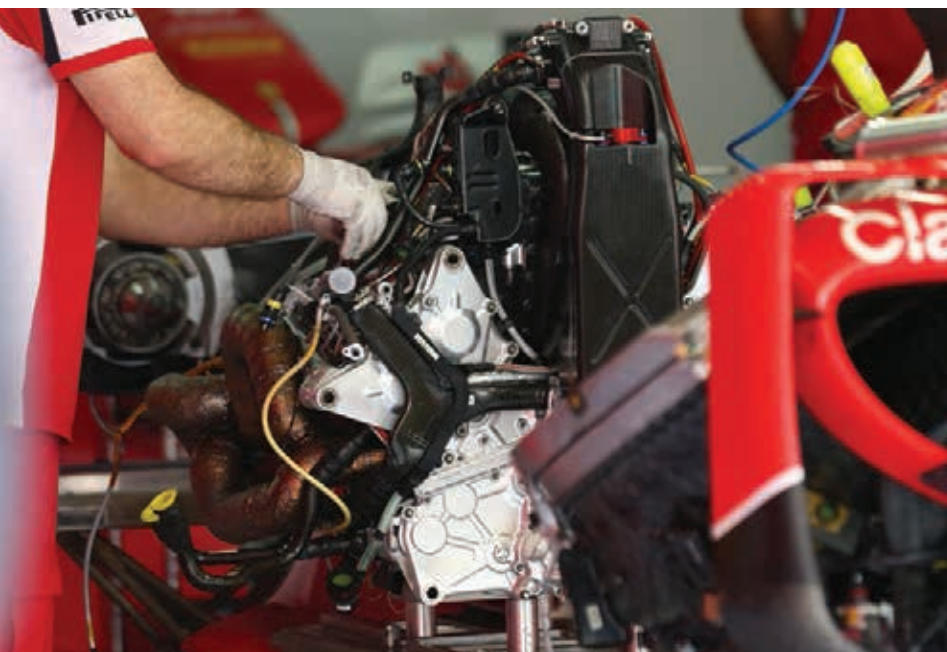

The exhausts have been re-routed for the 2015 version and they are now *always* swathed in thermal barrier



These Magneti Marelli injectors are the same as used in the 059/4, though they may differ in appearance

technical partnerships. The introduction of direct injection in 2014 was something of a step into the unknown for Ferrari and it turned to electronic specialists at Magneti Marelli to help, but even for them it was a steep learning curve.

Roberto Dalla, motorsport director at Magneti Marelli, said: 'We started on the project using the experience of our production car products, they were way ahead of us in terms of experience and technologies as we had not done a GDI system for motorsport. So we took onboard their experience, but not their product, as a basis. We decided to start over and build a brand new 500bar injector for F1 V6 engines.'

The injector pictured below is the same as that used on the Ferrari V6, though likely not in the exact configuration used currently.

Bespoke injectors

'It is very customisable by design as we know every customer wants its own solution,' Dalla says. 'They want different nose lengths, larger or smaller sizes, things like that. It's not only the nozzle section that changes a lot it's the whole thing because it all interacts, the whole dynamic of the injector has big influence on combustion.'

Ferrari is not the only PU manufacturer to use the Marelli injector, and this has seen many variations of the design being developed. 'There are different types of developments going on, the mechanical developments can take some time but the customisation of the nozzles and other related parts to change the fuel spray can be done very quickly, in perhaps two weeks from concept to delivery, and that's really important for the engine builders,' Dalla says. 'They are doing so many variations, in the last two years we have done maybe 70 or 80 different nose configurations and perhaps even more nozzles. Now we are passing the experience from the F1 project back to production cars.'

The fuel injected by the Marelli injectors is also a key area of development, and Ferrari is working as it has done for many years with Shell to develop the ideal fuel for the V6 engine. But here too some of the working practices of 2014 have changed to improve performance.

'We have done a lot of fuel work on these power units, it's a big area because you can change it as often as you like without using any tokens, and developments in that area make some things possible in terms of combustion that would not be otherwise doable,' Fraboni explains. 'Last year we were developing in parallel with Shell, but this year we have set targets to them in terms of performance and especially knock. They now know where we want to go and what we want to achieve with the engine and they have to get there. So each time we go to the dyno they will bring a number of candidate fuels to test to make sure we have the best for the races. I think now it is a very close relationship.'

The significance of fuel development has increased substantially

The significance of fuel development has increased substantially with the introduction of the new V6 engines and this can be seen by how closely the manufacturers are working with suppliers, Mercedes with Petronas and Renault with Total. Says Guy Lovett, innovation manager at Shell Motorsport: 'The fuel development has been an intense area of activity since 2013 for us. That is not to say that we have not done anything with the oils but the proportional gains have been greater in terms of the fuel.'

The possibility to improve performance with the V8s was always there with the fuel, but the opportunities then were probably that much greater with the oils. 'We have seen with the new power units that the balance has significantly shifted, the new V6s are incredibly responsive to fuel, they have a different appetite for fuel to the V8s and that is an area where we have exploited our experience with turbo engines from other areas of motorsport.'

Technology also transferred from production

cars into the racing fuel for Ferrari as well as the expertise from other series such as WRC and WEC. 'We have benefited from some of the road car fuel development for GDI engines, though the applications are a bit different,' continues Lovett. 'The temperatures are a bit higher in the racing engines tip temperatures, but the detergent technologies are the same in the road fuel as the race fuel. It's actually much easier in F1 where we are developing a product for a single engine. We have intimate details of every aspect of the engine and we have complete information sharing. It's a one team approach now. That lets us get into the minute details of the formulation to let us optimise to the design, on production cars you can't do that. But there is some commonality between the applications so the motorsport technologies are extracted and applied back to the road car products at the pump. It's why Shell is in Formula 1, it's not just marketing, it's real technology development.'

Fuel flow

One technology not a major feature on the road but increasingly so on the race track is the use of fuel flow limits, either by restrictors such as in GT500 racing in Japan, or by flow sensors in WEC and Formula 1.

'I think the challenge with flow meters is an interesting one,' Lovett says. 'The balance of how we formulate the different fuels does subtly change, so parameters like anti knock and flame speed, which are good for performance, are typically not so good for energy density, so we need to continuously optimise the fuel to get a good calorific performance within the given flow and consumption limits. The same is true for the WEC. The challenge there is that the fuel works across all the different demands of the different manufacturers, so they all had to work together with us to get an optimum fuel.'

Shell does not only supply Ferrari with its fuel, but also other bespoke products. Indeed, according to Lovett it supplies every fluid apart from brake fluid to the Scuderia and its customer teams, Sauber and Manor. Interestingly the latter retained the older 059/3 power unit for 2015 and Shell still supplies it (via Ferrari) with its 2014 product.

Lubricants are clearly still a major area of engine development and not just in terms of reducing friction, Fraboni explains: 'The oil also has an effect on the detonation so it's very important not only for friction reduction and performance but also reliability. If you want to reduce the cooling on the car then there is a lot to do with the oils, the flow rate, things like that, you can use the oil formulation to close up the radiators a bit too.'

With only four complete power units allowed per car per season in F1 each engine has to operate in a variety of conditions, from



Plenum is smallest in F1, suggesting 059/4 does not feature variable inlet. Wastegate configuration has changed from 2014



059/4 power unit installation – this picture graphically illustrates the mind-boggling complexity of a modern Formula 1 car



Shell works very closely with Ferrari and says it supplies all the F1 car's fluids except for the brake fluid. Ferrari says Shell's input into the engine's development has been vital

the high speed tracks at Monza and Spa, to the heat of Singapore and the high altitude of Mexico City. Rather than using a bespoke oil for each venue, though, as was once the case in F1 (during the V10 era) Ferrari and Shell claim to stick to roughly the same spec for a number of venues. 'We tell Shell what we want to do and then we try things out on the dyno,' Fraboni says. 'Sometimes you take something that you know is marginal to see if it is worth risking it. Basically though we run the same oils, for quite some time, the engines have to do a lot of races so we don't change it too much each year. We need an oil that can survive all the conditions.'

But the fuel flow and fuel consumption limited formula of modern Formula 1 (and LMP1) places a serious emphasis on increasing efficiency, and that does mean that reductions in friction do result in big rewards on track. 'We are always hunting friction reductions because of that,' Lovett says. 'With a finite amount of fuel going in [100kg], any efficiency gain you can make is heavily rewarded in lap time. It's a big win, that remains our key drive for lubrication. We want to reduce the viscosity of the oil as much as we can, as long as we avoid metal to metal contact we can reduce friction. But it's not that easy as every component has differing demands. It's not just about viscosity; there are other parameters to look at. We have to protect these engines. If we take viscosity down too far we get into issues with durability and wear, and ultimately an expiration of the engine before its design life.'

In recent years much has been made of the development of surface coatings and they have now become an essential part of a racing engine's design and construction, the Ferrari

V6 included, according to Lovett: 'We are right with Ferrari working on the coatings,' he says. 'We like to call it co-engineering, so we optimise our lubricants around the latest surface coatings and surface finishes. A DLC [coating] contact is very different to a metal-metal contact, ideally we would like to have six different lubricants in the engine for different areas but you can't really do that!'

Unwilling to disclose

One new area where Shell is making a bespoke product for Ferrari, but is unwilling to disclose details, is in the energy recovery system, which requires a special cooling fluid. As said, information on this is not available.

The 059/3 was not the first hybrid power unit for Ferrari, the 056 V8 also featured a hybrid system in 2009, 2011, 2012 and 2013, and one of the key suppliers to that project was once again Magneti Marelli.

'We started in 2009 with a solution on the MGU-K,' Dalla says. 'We understood then that the voltage was very important so the evolution of that 2009 solution saw us go down in voltage because under those regulations, at that time with the experience we had then, going down in voltage allowed you to reduce the battery size and improve overall car performance. In 2011 we were able to use a battery that was less than half the weight of the battery we used in 2009, because of the pursuit of that voltage reduction.'

The 2009-2013 MGU-K was a 60kW device and proved popular, and a variant of it was believed to have been fitted to Peugeot Sports stillborn 908 LMP1 hybrid. But in 2014 the importance of the hybrid system on overall car performance increased drastically with

the new power unit rules.

'In 2014 with the introduction of the MGU-H there was a paradigm shift, the way the MGU-K was used changed completely and we moved in the opposite direction as a result and increased the voltage to over 450v because the overall car package would be better with a higher voltage,' Dalla continues. 'Going up in voltage and the higher power motor [120kw as opposed to 60kw] and the different type of usage. But we had to develop a highly customisable solution again, both for the motor and the control electronics.'

As you might expect with the increase in both voltage and power the 2015 specification MGU is much larger and heavier than the 2009-2013 version, but tipping the scales at 10kg its weight has certainly not increased in proportion to its potency.

'The biggest step has come in the control electronics, and here there are still big gains to come in that area,' Dalla says. 'At the moment the weight is about 3kg. We have a big constraint with this part, the capacitor. From 2014 to today it is an area we have plans to improve and we have some clever ideas to come which will reduce the weight substantially. The power' →

The fuel flow and fuel consumption limited formula of modern F1 places an emphasis on increasing efficiency

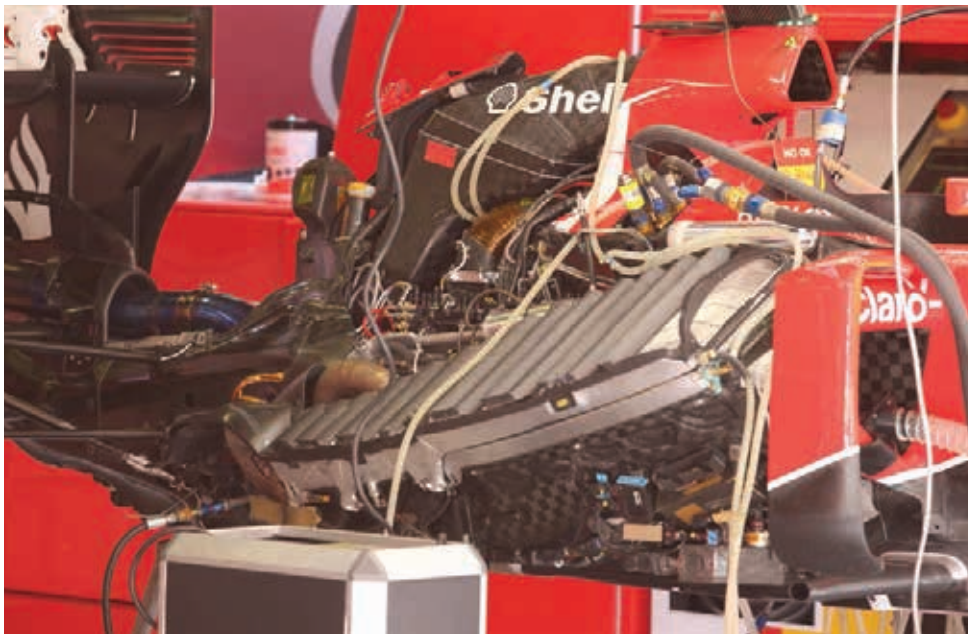

Cooling is vital with new breed of power units and Ferrari has crafted louvred coolers to help with heat efficiency on 059/4



Magneti Marelli MGU-K can pack 120kW and 450v and weighs 10kg – which seems a fair trade off when all's said and done



Magneti Marelli is trying to reduce the weight of the capacitors, which are housed in the black section of the inverter

modules will be completely revised, so I think we will show a very big step in the near future.' Dalla goes on to point out that the developing technologies in motorsport energy recovery systems are rapidly becoming a great area of focus for all concerned, not just for their on track performance, but also their wider relevance.

'In the current regulations there is this wonderful element, the link between MGU-H and MGU-K which is a very open door and there are very few constraints in this area.

'These electric motors have more than 95 per cent efficiency. Introducing this technology to road cars will take time but it will happen, with 95 per cent efficiency you will see its importance in series production grow and grow, as focus on fuel consumption intensifies,' he states with detectable excitement.

'What really excites me is the ERS-H because there is the potential to recover so much waste energy, you will see it tomorrow in Formula 1 and down the road in series production, but you can reduce the importance of the battery in a hybrid car, because right now the battery is the weak point,' Dalla adds.

Work in progress

While Dalla enthuses about the potential of ERS-H his company does not supply the full system to Ferrari. The MGU-H often shown on the internet as being Ferrari's solution, with the MGU-H mounted between the compressor and turbine, is in fact just a demonstration part from Marelli and not the Ferrari solution at all. Indeed, in general the design of MGU-Hs in Formula 1 remain largely secret.

But Dalla stresses that the importance of them and indeed the MGU-K is likely to grow in the very near future, perhaps even by 2017 as Formula 1 contemplates its own existence. 'The power units have moved from 32 per cent efficiency with the V8s to 40 to 45 per cent efficiency. That's wonderful, now Formula 1 is looking to what comes next, and the idea of a more powerful power unit, 1000bhp or more easily, is an interesting idea.

'I'm pretty sure that will come, but the big question in meetings now is how to reach it. If you reach it with the fuel it's easy, but you lose that efficiency which you have worked hard for, and it's bad in terms of image, so I feel sure that the power increase will come from the ERS. It's the only way to do it,' Dalla concludes.

Ferrari's power unit is still very much a work in progress. Even in 2015, new fuel and oil specifications are still to be introduced, and some of the development tokens will be spent on combustion and reportedly a new MGU-K, as the Italians try to continue to close the gap to the seemingly less dominant Mercedes. 'The engine is still at the beginning of its development and we are still having new ideas each week, there is still much more to come,' Fraboni says. Which is surely a warning the Scuderia's rivals will take very seriously. 

progressive braking

Leading the way in braking innovation



At Alcon, we push brake technology as hard as you push on the track. For over 30 years, Alcon have been supplying winning solutions to competitors in series ranging from F1 to grassroots motorsport and everything in between.

Alcon constantly push the boundaries on caliper, disc and actuation technology and new materials. So whether you compete off-road or on the track, you can rely on Alcon's expertise to help you win.

Contact us today to see how Alcon can help with your brake or clutch requirements.

HEAD OFFICE UK +44 (0)1827 723 700

alcon
specialist brakes & clutches

www.alcon.co.uk



Fall from power

Year two of the new F1 regulations has been painful for Renault – but just what has gone wrong with the multi-title winning engine maker's power unit?

By SAM COLLINS

Renault Sport F1 has been in the headlines a great deal during the 2015 Formula 1 season, but often for the wrong reasons. Despite winning three races in 2014, and the Renault-powered Red Bull team finishing runner up in the constructors' championship, the French marque has so far not enjoyed the current engine formula. The 2015 season has started out in the same way as 2014, with the French firm's Formula 1 power units proving to be unreliable from the first race. But unlike 2014, where performance and reliability rapidly improved, this season has been much more of a struggle.

'Clearly last year was pretty difficult in the beginning, but we made decent headway and it was pretty decent in the middle,' says Rob White, deputy managing director (technical) of Renault Sport F1. 'Our objectives for this year were to bring performance to the cars and sort out the reliability trouble that we had had in 2014. The second cycle of a power unit is difficult, because you end up doing the design and development work before you have really understood what has gone on with the one before. When the one before is difficult it makes it difficult to make the right choices for the next one.'

Perhaps unsurprisingly the 2015 specification Renault power unit, officially called the Energy F1-2015 but still believed to be known internally as the RS34, is in overall design terms quite similar to the 2014 version. By regulation the 1.6 litre V6 engine shares many of the dimensions of the 2014 version, including cylinder bore spacing and deck height, as well as retaining the complete air valve system. Other design concepts and the general layout have also carried over: the MGU-K still sits on the left of the engine block under the exhaust header, the MGU-H residing in the V of the engine but with both compressor and turbine mounted at the rear of the V6. Compared to the 2014 design, the exhaust concept is also similar, though perhaps the turbine entry is positioned slightly lower in the car.

One of the criticisms levelled at Renault is that the design of its power unit is perhaps too conservative, lacking obvious features like a split turbo or log exhaust, but White denies strongly that any of these concepts are really an issue.

'We don't see any power unit reason to do anything other than we have done in terms of layout, and anything else we do or don't do is for chassis reasons, not those of the power unit,'

he says. 'We recognise that we are significantly behind the best in terms of flat out performance but we don't believe that the gap lies in the layout of the compressor, turbine and MGU-H.'

Peer pressure

'We are behind where we wanted to be a year ago,' White adds, 'and back then people, including *Racecar Engineering*, leant on me to try and justify why I did not have an exhaust that looked like the one used by Mercedes. We could not see from our understanding how last year's [Mercedes] solution could be better than the one we had, but it was their optimisation, and that could have been driven by a chassis demand. The solution they have this year looks a lot more like the one we have, but they are still a long way ahead of us in terms of performance. There is not a silver bullet in any visible area of the power unit. It is the sum of all of the small decisions and clearly our job is to deliver more performance that way rather than find one magic choice.'

One major difference between the 2014 and 2015 V6 engines is the use of a variable inlet, evidenced by the much larger plenum seen on this year's power unit. While variable inlets

From the first race it became clear that almost all of the Renault powered cars were going to be hit by penalties at some point during the season

Renault powered Red Bull has struggled for competitiveness this year after winning three races in 2014 and enjoying a run of four championship wins before that. Some suggest its engine supplier is to blame



have been used in Formula 1 before, they have been outlawed for many years, including 2014. However, the ban was lifted at the start of the 2015 season (something that was long planned).

While it may seem an obvious choice for a manufacturer to take advantage of it, it is not clear if every power unit in use in 2015 utilises a variable inlet, though Renault has been very open in admitting that it does. However, for obvious reasons, White is only willing to discuss this area of the power unit in general terms. 'We have one, I don't know if everyone has one but we do, I can tell you that much,' he says, before explaining the major considerations when installing such a system on a current power unit.

Acoustic tuning

'It's all about the acoustic tuning of the inlet system,' White says. 'A variable geometry system allows you to vary that tuning. But there is a trade off, a variable geometry system has more bits in it and its therefore heavier. There are compromises in the system itself, too, where you have the moving bits you have sliding seals, steps, and there are some real negatives due to that as well as the clear positives. Depending on the engine the outcomes can be quite different.'

In developing its solution, Renault evaluated a number of different layouts and mechanisms before settling on the system it now utilises.

'There are some acoustic solutions for the inlet systems that are easier to implement than others,' says White. 'If you look historically, when we were allowed variable inlets, most people had sliding trumpets that went up and down, that's a solution which is possible for these engines, but the trumpets are much longer and the stroke you need is longer so it takes up a lot more space. Most road cars that use such systems have some sort of rotating device, which is an option but is a compromise for the gas passages. In addition you might choose to have separate plenums, a single plenum, you could choose to join all the inlet runners together and have a single throttle per set of three or set of six. So there are many acoustic solutions and the results of the trade offs probably varies from engine to engine even in Formula 1 right now.'

With the new engine specification largely decided on, Renault Sport went into the winter ready to prepare for the 2015 season, but what at first appeared to be a simple FIA clerical error, resulting in the homologation date for

the 2015 power being left out of the technical regulations, became rather more significant and had an impact on Renault's entire season.

'It was probably the only significant unknown in the latter part of 2014,' White says. 'But it all appeared to have settled down and we believed that there would be no in season development allowed. Then, just before Christmas it became apparent that the reverse was the case. We should not exaggerate the importance of that, though it changed our implementation plans somewhat it meant that we spent fewer tokens over the winter than we would have spent in order to hold back tokens for an in-season performance step.' While White makes it clear that the unexpected introduction of in-season development was a setback it was not a major one, though it did have a knock on impact on the Renault programme. 'It's fair to say that the change came late, and as a consequence the first race spec that we ran with came about rather late. Clearly at the time we wanted that spec to be a banker, we wanted it to be safe in terms of reliability, and in terms of performance it would be a modest step, but it would be a springboard to a more significant step later on. It did not play out quite that way.'



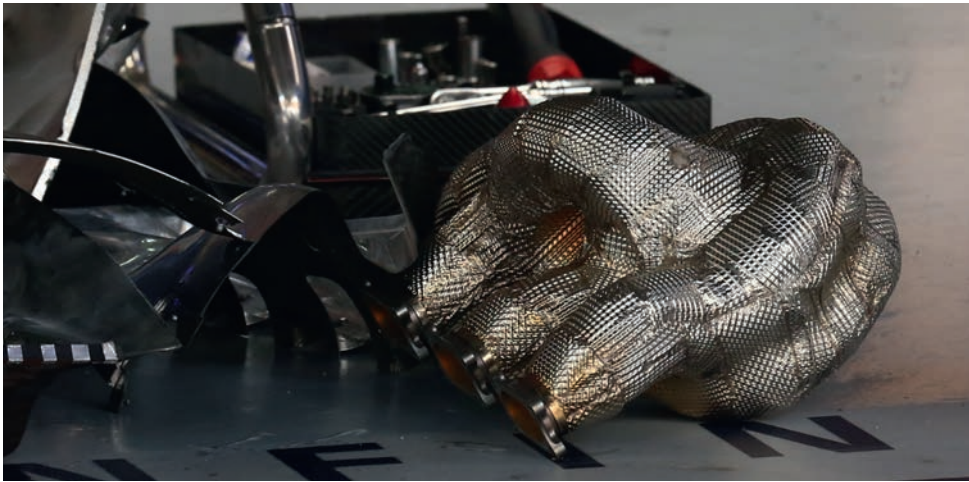

Renault RS34 exhaust headers with heat shield. Mercedes moved to this style of exhaust for the 2015 season, which is ironic as last year Renault was widely criticised for not following Merc's lead when it came to the design of the exhausts



The top of the V6 power unit with the plenum removed. This year Renault switched to a variable inlet and this is one of the major differences between last year's unit and the 2015 engine – these were not allowed in Formula 1 during 2014 season

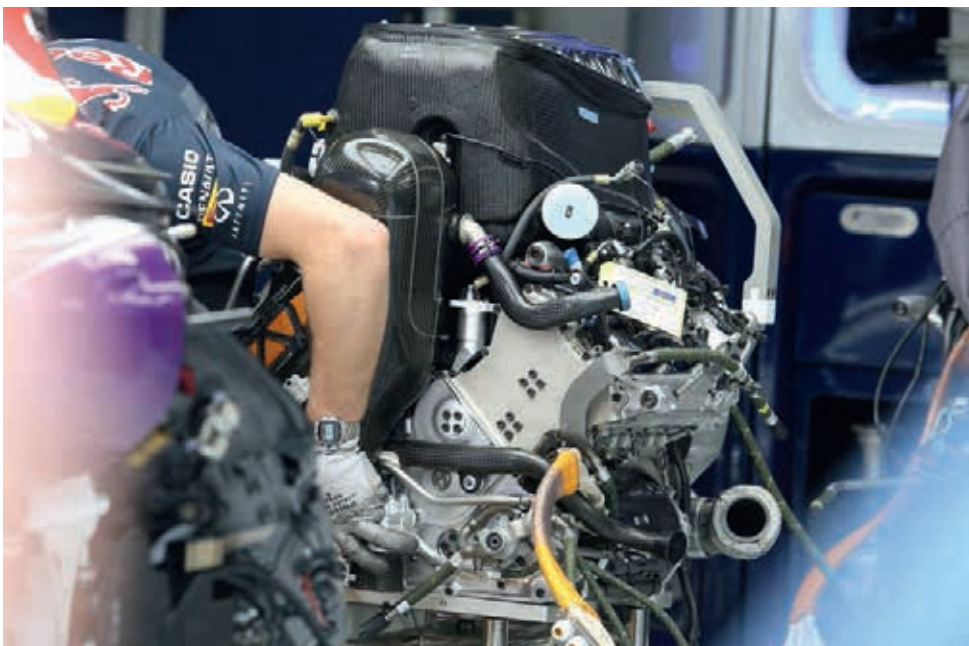

A shot of the V6 engine in its entirety. The MGU-K is visible, as is the turbine inlet and oil tank – the latter of which is a carry over from the 2014 powerplant. The engine is actually officially named the Energy F1-2015, but most call it the RS34

During the 2015 Formula 1 season each car is only allowed to use four complete power units, a significant reduction from 2014, where they could use five units with fewer races. Exceeding the allowed number of units results in draconian penalties being applied. But from the first race it became clear that almost all of the Renault powered cars were going to be hit by penalties at some point during the season.

'We had the first signs of reliability trouble immediately before the start of the season, during the last Barcelona test,' White reveals. 'Then we had a couple of incidents in Melbourne that put us on the back foot, one of which was a failure of a transmission component between the engine and the MGU-K and one of which was a car related issue, something in the gearbox which damaged the engine. So we used up two engines in Australia that we would clearly have not wanted to. Indeed the spares we had to put in were fitted with some components that we would rather have not had to use as there was a late-arriving durability upgrade that was not fitted to them.'

Taking penalties

The replacement engines meant that some of the Renault runners were half way through their season's allocation by the second race and with power units that the French firm knew were not as durable as they should be. The manifestation of further problems was inevitable. 'We knew that those engines would cause us trouble later on,' White says, 'and we knew it was unlikely that we would get away with not having any penalties later in the season. We did not at that stage foresee all that was yet to unfold.'

Pre-season testing did not start well for Renault. Just before the team left for Jerez a manufacturing defect was found with a shaft in the ERS system coolant pump. The defect was enough to limit the running of both Renault powered cars at the test, though they still completed significant mileage.

Renault Sport F1's managing director Cyril Abiteboul explained at the time: 'It is something that was working very well last year, but we decided to change and improve it a bit further with the overall packaging of the engine to also support Red Bull in their attempt to also have very good packaging. That is why we did not really care for that part. Usually you have very specific simulations, design tests, and validation protocol. But honestly we did not do it for this part because it is such a stupid part.'

Things did not improve, with the full 2015 specification power unit only deployed at the final Barcelona test an unexpected issue not found in the test engines used at Jerez and in the first test at Barcelona manifested itself, White tells us: 'One of the issues we saw in Barcelona was with the pistons, so early on we had to change the pistons in order to address that issue, but it was not a sufficient fix and we still had trouble with the top of the pistons in the



A picture of the 2014 V6 engine for the purpose of comparison – it looks as though it has a different MGU-K and turbine entry. This engine powered Red Bull to three wins last year

race engines. This led to the failures in China and Bahrain. We found that they were failing due to mechanical and thermal loads which were higher than we expected. The design change solved that.'

It's fair to say that Renault felt the pain of the opening part of the season but this seems to have spurred them on to resolve the problems and move forward, and while the situation is clearly not that of Mercedes or Ferrari it is clearly better than it was at the start of 2015. 'It's a Roald Dahl butterfly type thing,' says White. 'When a small number of bad things happened some time ago, we have got those things under control and we are now heading forwards with the nose to the grindstone to get back on track, but it's clear that we have lost time and ground relative to where we wanted to be.'

Moving forward will involve Renault starting to spend some of the performance upgrade tokens it has remaining. The French manufacturer spent the fewest tokens during the winter, just 20 of the 32 allowed, and planned a major upgrade kit for the European season, but by the British Grand Prix no performance upgrades had been made. 'The reliability issues delayed our development programme, as we had not really understood the nature of the problem. Logistically it was extremely challenging. It became necessary to build engines that we did not expect to build in a spec that we did not have confidence in at the time. That is now behind us, the engines we have introduced since Monaco have been

completely trouble free in terms of those issues we saw early on. We have now got decent mileage on the engines, and we are reassured that the validation criteria are now the right ones, and that the spec is robust,' White says, before adding: 'Unfortunately we are talking in July and not in March.'

Token gesture

Renault's performance in comparison to Mercedes has sparked some calls in the media and in senior F1 circles for the token system to be abandoned to help struggling manufacturers to catch up. One of the loudest critics is Red Bull's Helmut Marko: 'We are significantly behind Mercedes. They clearly dominate. But because the rules are not open it means that you are only allowed to make changes on a very limited scale which makes it very difficult, if not impossible, to catch up,' he said during the first half of the 2015 season. But White disagrees with this stance and claims that it is not the development restrictions in the rules that is holding Renault back.

'There is nothing that we have wanted to do that we have been inhibited from doing by the restrictions in the rules. The token allocation at this stage of the power unit development is absolutely not an obstacle to performance development, so we should not get hung up on tokens or homologation restrictions because they are no obstacle to progression. It is not stopping us bringing performance, in the past, the present, or indeed in the short-term future. That may not be the case further

down the line, but for the time being it's not an issue,' White insists.

Development freeze

However, at the start of 2015 some areas of the power unit were already frozen in terms of development, and at the end of the season more areas will also be locked in. 'There is nothing we consider to be very sensitive for performance included in the progressive freeze at the moment or indeed by the reduction of tokens,' White says. One of the areas included in the freeze at the end of the 2015 season is the ancillaries drive, which it could be argued also limits the location of some of the ancillary components such as water pumps and similar, which while they do not have an impact directly on engine performance are a key part of the overall packaging of the car. 'You have to be extremely careful about how the rules have been written, how they are interpreted and how they are implemented,' White says. 'It's understood and accepted that changes that are

One of the criticisms levelled at Renault is that the design of its power unit is perhaps too conservative

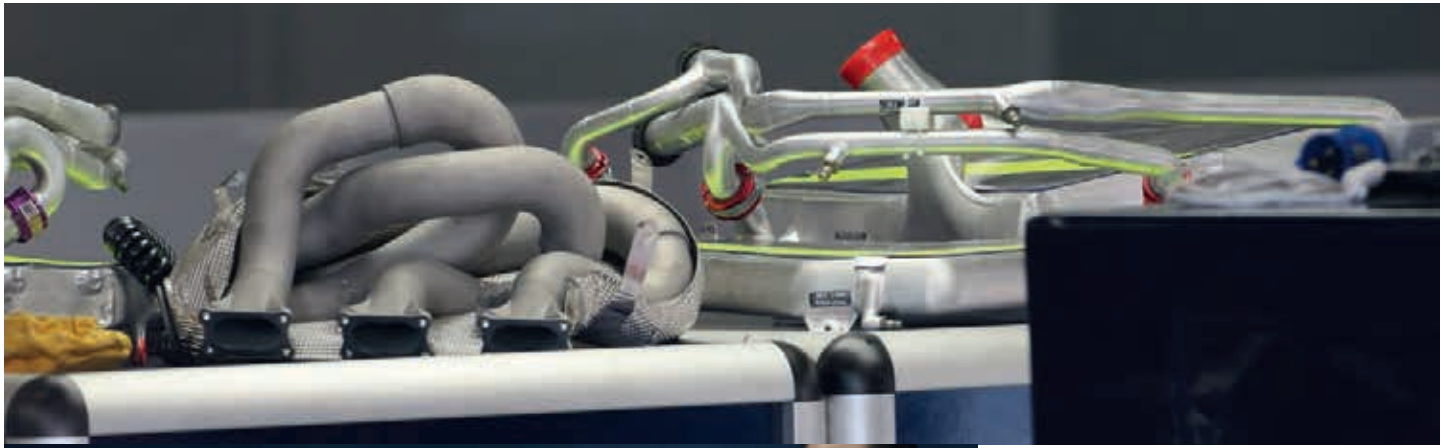

Above: The exhaust header with heat shielding removed – it appears to have been treated with a ceramic coating to further protect against heat
Left: The Friday press conferences on grand prix weekends have sometimes been uncomfortable occasions for Renault boss Cyril Abiteboul this year

But it is slightly flawed in real life, and as it's a fundamental performance driver it's a touchy subject. The meters are troublesome in that they have erratic behaviours. The precision or fundamental accuracy are not in question. I think if the fuel meters respected the nominal specification under all real world circumstances then it would be a non-subject but the sources of trouble are the slightly uncertain inconsistencies at the boundaries.'

The next step

Renault Sport F1 now has to find the right time and the right set of performance upgrades to introduce in the right way to be able to take its customers back to where they feel that they should be, at the front end of the field. But with the engine penalties looming this is far from a straightforward task, especially seeing as the penalty structure will be revised for the power unit-dominated Belgian Grand Prix. White says: 'The fundamental work to generate the performance back at the factory and the implementation of that downstream has become a juggling act in order to have that work complete to make sure that the new spec engines are available at the track, then working out with Toro Rosso and Red Bull how to introduce the engines, bearing in mind that only one of the drivers can get to the end of the season without taking penalties. All the rest now take penalties when new engines are introduced, so there is a trade-off between penalties taken and performance improvement.'

Just how big that performance improvement is remains to be seen, but the Red Bull teams hope that it will be enough to see them at least mixing it up with the likes of Williams and Ferrari and, just perhaps, on the right day on the right track, maybe the Mercedes works team too.



not for performance reasons but are for chassis installation reasons, which indirectly brings performance to the car, are not subject to token spend. But that's a debate to be had with the FIA technical team. It is the case that the whole power unit is in the performance table and there are some things that can't or just don't bring power unit performance. So in essence the tokens that are available for those components can be used for things that do bring power unit performance. That's one of the main reasons that the tokens just are not an obstacle at the moment. We have had discussions about the weighting of the tokens and the scope of them, but it's slightly esoteric and off-line.'

While Renault has, at the time of writing, not spent its tokens or revealed how or when those tokens will be spent, one area in which it is almost certain that either Renault or its customer teams will at least experiment with is the introduction of a new fuel flow meter.

A Renault powered Red Bull was disqualified from a podium position at the opening race of the 2014 Formula 1 season due to a fuel flow meter irregularity and the issue remains a touchy one for all involved. So perhaps then it is a surprise that with a new flow meter from a different supplier, and using a slightly different technology being fully homologated just before the British Grand Prix, that the engineers at Renault's Viry Chatillon base have not tested it. 'The honest answer is that we have not even seen the new one. We can only consider something that is homologated and not something that isn't,' White explains.

It seems that one flow meter is likely to offer a power unit performance advantage over the other but it remains to be seen which will offer that advantage. 'It's one of these cases where a man with two watches does not know what time it is,' White points out. 'The technology of the flow meters is extremely impressive and it's almost a very good piece.'

'The reliability issues delayed our development programme, as we had not really understood the nature of the problem'



RACING

BALANCED BRAKING PERFORMANCE

All the way to the APEX

BITE

DECELERATION

MODULATION

RELLEASE

THE DRIVER'S
PAD

FERODO RACING BRAKE PADS

developed and engineered to perform in all four phases of the braking event.

In addition to the bite and deceleration expected from a world class race pad, Ferodo pads offer the superior modulation and instantaneous release for maximum exit speeds.



Circuit Supplies (UK) Ltd, Unit 8, Eden Court,
Eden Way, Leighton Buzzard, Beds LU7 4FY
Tel: 01525 385 888 • Fax: 01525 385 898
info@circuitsupplies.com
www.circuitsupplies.com

www.ferodoracing.com

SELECTED RANGE NOW AVAILABLE
THERMALLY BEDDED

Power struggle

It's been more 'power of nightmares' than 'power of dreams' since Honda returned to F1 with McLaren this season. But just what has gone wrong?

By SAM COLLINS

'The 2008 and 2009 Formula 1 hybrid system experience was very useful'



Honda's return to Formula 1 was announced with great bravado. In these very pages Yasuhisa Arai, the man tasked with bringing the famous Japanese marque back to grand prix racing, revealed that he expected that the McLaren MP4-30s using the RA615H power unit would be at the front of the grid from the start of the season.

However, since Arai made the claim (RCEV24N12) it's fair to say that things have not quite turned out the way he envisaged, and a quick scan of the results of the first half of the 2015 Formula 1 season provides a harsh reality check. The statistics show that the Honda power unit has seriously under-

performed. In fact, the reliability of the McLaren-Honda, the only car using the RA615H has been woeful, and the performance of the cars has not been much better.

It's not all been bad, though, and there are signs of improvement. At Monaco the MP4-30 scored its first points of the year with an eighth place and the car's outright pace has progressively improved. But still, it's clear that things have not really gone the way Honda, and many in racing, expected. So what's gone wrong?

'We lacked time,' Arai admits now. 'We started work on the power unit in May 2013, at that time we had nothing, no drawings, no parts, no concept,

but we fired up the V6 engine for the first time in the Autumn of 2013. This early test was not reported in the media, though some sources in Japan suggest that the first mono-cylinder work began as long ago as October 2012, when the *Racecar Engineering* website broke the news of Honda's return to F1.

The move to a new turbocharged, downsized engine formula based on efficiency was one of the key attractions that lured Honda back into grand prix racing after it quit the sport at the end of the 2008 season. It had already designed, built and tested a mild hybrid Formula 1 car as part of the re-introduction of hybrid systems into F1 in 2009. The unraced Honda RA109 F1 car is widely said to



Main picture: Honda's RA615H has proved disappointing thus far in Formula 1, but many in the paddock believe it has potential. It features a Birman type exhaust layout, which can give much better gas flow to the turbine and allows for better energy recovery from the MGU-H. **Below:** Honda was attracted back into F1 by the new engine rules which call for 1.6-litre hybrid power units. The V6 engine itself has its roots in other Honda projects

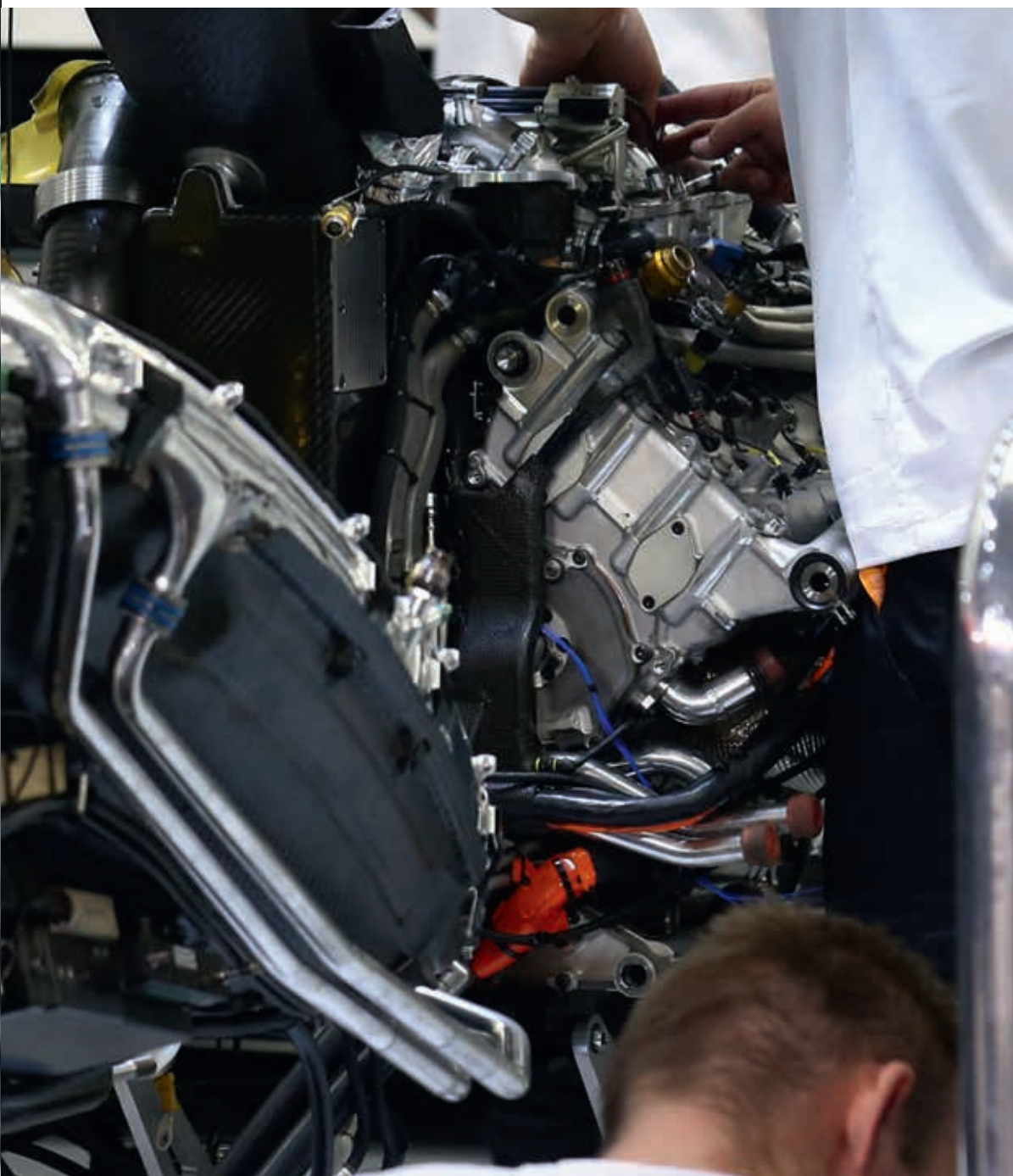

have been rebranded as the title winning Brawn BGP001, but in reality it was a very distinct design with a unique energy storage layout, mounting the batteries in front of and under the legs of the driver, while all of Honda's rivals mounted the energy store below or behind the fuel cell.

This project and the technologies used in it laid the foundations for a new Honda hybrid system for motor racing, but its evolution saw Honda engineers taking advantage of the firm's wide motorsport involvement, too. 'The 2008 and 2009 Formula 1 system experience was very useful in this project,' Arai says. 'I think that hybrid system was really, really good for that time with the high RPM engines and

the energy storage layout that they had proposed. The Honda design had good control systems too. Then there was the GT300 hybrid system used on the CR-Z, it was made by Zytex in England but the design was all done by Honda; the motor layout and transmission was all Honda. We used a lot of the lessons from the third era F1 system on that, then the lessons from developing the GT300 system on the track were very helpful in the creation of the current MGU design.'

The V6 engine itself also has its roots in existing high performance Honda projects, with the firm having developed power units for Super Formula, GT500, WTCC and LMP2 (the latter ICE also being

used in the GT300 CR-Z). 'We took the basic understanding of the technology of this engine from the GT500 NRE engine [a 2-litre in-line four], the direct injection, turbocharging, small displacement all of those things. The combustion chamber from that was an especially helpful starting point for the F1 V6 as it is very similar. The WTCC engine is quite different because of the restrictions on boost pressure in that class and that means it has a different combustion concept, but the overall architecture and concept was also helpful in terms of knowledge,' Arai reveals.

Once the overall layout of the Honda power unit was defined the first physical prototypes could

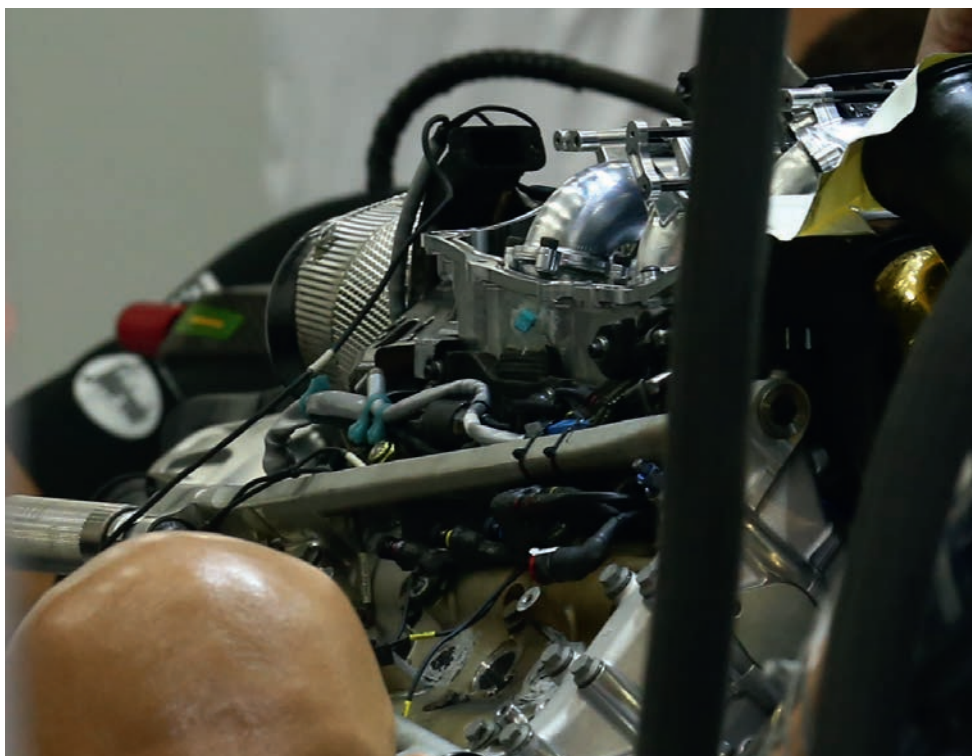

In this image the ducting to the intercooler, mounted in the right hand side pod of this year's McLaren MP4-30, can be seen. The pipe coated in the gold-coloured heat shield appears to be there to supply the air from the compressor to the intercooler

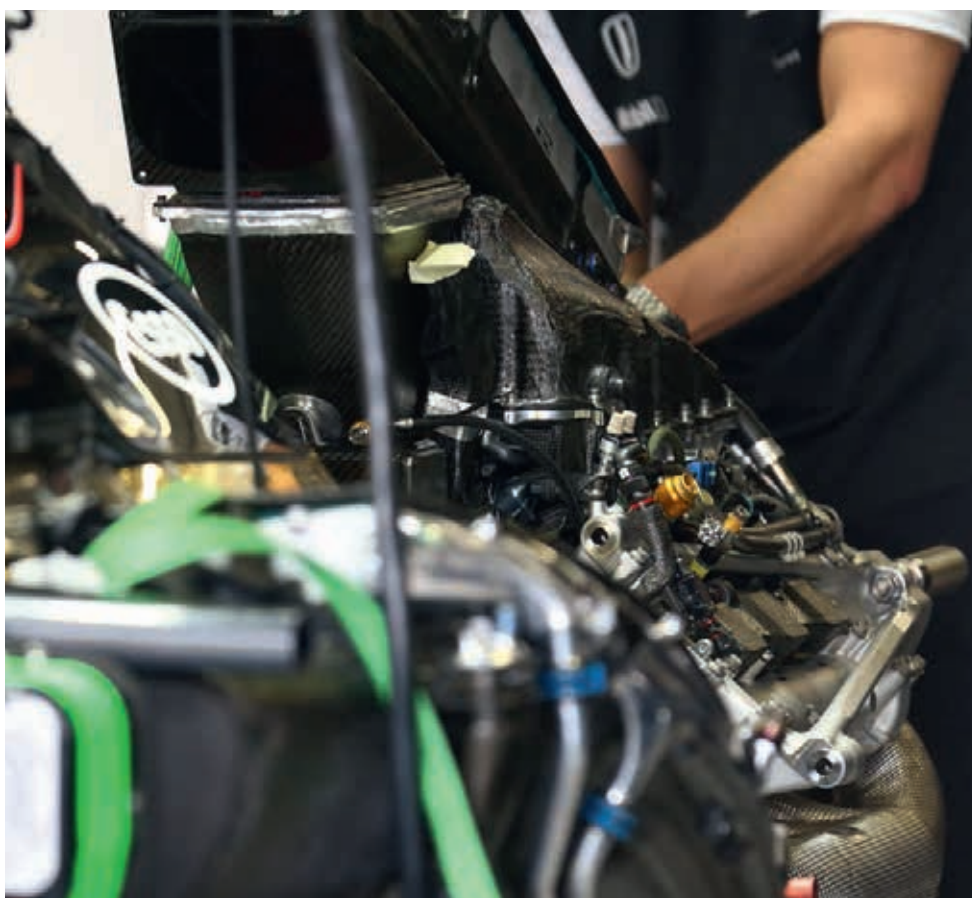

At the start of the 2015 season the RA615H featured a machined aluminium plenum, unique in Formula 1, but this was simply for reliability purposes and Honda has now reverted back to this composite plenum, as included in original design

Almost immediately the Honda engineers realised the challenge that they faced

be made and tested at the Japanese marque's secretive R&D facility near Utsonomiya, Japan.

'The early test bench running was literally just to confirm the very basic concept,' Arai continues. 'From there we did a lot of development, and finally in Silverstone and Abu Dhabi we used an old McLaren chassis to confirm the whole system.' That 'old' McLaren chassis was in fact a 2014 MP4-29 adapted to accommodate the new Honda power unit. Officially the car was called the McLaren MP4-29H 1x1, the 1x1 referring to the prototype Honda power unit used in the car.

Tim Goss, McLaren Racing technical director explains: 'The MP4-29H was a mule car to prove out some of the systems. While Honda has experience in hybrid power units, this current breed of F1 engines is unlike anything anyone has come across before, so Honda needed a platform to test those systems. Most of the key decisions on power unit and car layout had been taken, we had not fully refined everything. We took an early version of the power unit and installed it into the MP4-29 with the primary objective of proving out some of the systems before we fully designed the MP4-30A.'

Early tests

Goss continues: 'Given that the MP4-29 was designed around the Mercedes power unit and we had since created something very different, it was not just an easy case of bolting it in. But we took the chassis and adapted the rear bulkhead. We took a MP4-29 gearbox casing and with some small modifications managed to adapt that for the differences in the rear face of the engine and bell-housing.'

The test mule was fitted with additional cooling ducts on one of its side pods, a solution not legal under the 2015 rules but as the car was merely for testing it did not matter. 'The packaging of the systems was not optimal but that was not the idea, it was to try out some of the systems,' Goss says.

The first test of the Honda power unit on track took place at Silverstone in the late Autumn of 2014 under a cloak of secrecy. But as is always the case with 'private' tests at such venues, details began to leak almost as soon as McLaren booked its track time. The test runs of the MP4-29H test car were part promotional and part shakedown, and almost immediately the Honda engineers realised the challenge that they faced. 'That was literally a test to see if the hybrid system and V6 were all working together, really that was a lot to do with control system checks,' Arai says. 'It was very complex to get it all working with MGU-H, MGU-K, ES, all of those things. We wanted to make sure these things all worked together properly.'

The Honda engineers, and indeed some of those from McLaren, expected that it would take to the track and turn a good number of laps at a decent speed, but the spy videos of the car showed that it was rather limping round

'Everyone wants to know about our compressor, but I cannot tell you much'

the course. 'We had so many electrical issues, it all went wrong, strange things like the wiring harness connectivity problems and things like that. There were issues with the control boards, when you got one working the other ones would fail, the communication between the systems was very difficult, but those were important lessons for the future,' Arai says.

The MP4-29H was then shipped to Abu Dhabi for a public test along with the rest of the Formula 1 field. Here things took a further turn for the worse. This was meant to be the first proper outing for the new power unit. As the McLaren engineers attempted to fire up the car nothing happened. After a long systems check the problem was found and the MP4-29H left the garage for a couple of installation laps, but an issue with the car's onboard electronic systems was giving incorrect fuelling data, causing it to stop on track.

On the second day of the test another mystery electrical problem stopped the car from going on track in the morning, then in the afternoon it managed an installation lap, but at the next attempt at a run the electronics again caused the power unit to shut down. After this McLaren decided to call it a day and return to England.

'That power unit was quite different to the one we have now, after those events we changed a lot of parts between the MP4-29H experimental car and what you see on the final power unit. The lessons we learned allowed us to redesign some of the areas of the MP4-30A to make things work better,' Arai says.

The numbers

The final power unit was homologated early in 2015, and its official name was revealed: the Honda RA615H (RA for 'racing automobile'). As with all current specification F1 engines the design is a hybrid power unit featuring a 1590cc-1600cc (the exact capacity has not been disclosed) turbocharged V6 engine using direct injection and mated to a pair of electric motor generator units. Much of the engine's overall architecture is defined by the regulations, which dictate the cylinder bank angle (90 degrees), the diameter of the bore (80mm), the crankshaft centre-line, and the minimum weight of the whole power unit at 145kg.

But there is still scope for much variation, particularly in terms of the design of the turbocharger and the hybrid system. On the RA615H the MGU-K is mounted on the left hand side of the crankcase under the exhaust manifold while the MGU-H is mounted in the V of the engine. The turbine is mounted at the rear of the engine while details of the design and location of the compressor have yet to be revealed – Honda engineers remain tight lipped on the subject: 'Everyone wants to know about

our compressor, but I cannot tell you much. We tried to make a good compact layout, it's a core part of the concept,' Arai says.

It is likely that the compressor concept has closely followed the split concept seen on the Mercedes V6. Another cue from the Mercedes PU106A is the use of the log type exhausts seen on the German marque's 2014 power unit, but dropped for the 2015 version (RCE V25N7). This solution uses gas dynamic rectifiers in the exhaust manifold which basically ensure that the exhaust gas pulses are directed to the turbine in the most effective way, meaning that the MGU-H can recover significantly more energy from the exhaust gasses at the turbine than is possible with a more conventional exhaust manifold. It is also notably smaller than a conventional design. 'It's a compromise with the aerodynamics, that's the main reason we did that,' Arai explains. 'We discussed the layout with McLaren, to find the most efficient way to design the complete car. A big exhaust system is easy to get good horsepower, but it's heavy and takes up a big volume. It can also lead to heat rejection issues, and its not very good in terms of the turbocharger performance to have such a big layout, we need a tight and tiny exhaust system.'

With the layout finalised and the RA615H installed in the back of the new McLaren MP4-

30A the Honda's first proper test would come at Jerez, but again things did not go according to plan and the car struggled to lap anywhere near the pace of its rivals and spent much of its time in the garage. There were operational failures as well as technical failures during the test, including one occasion when the V6 was fired up without enough oil in it. 'There we had the first proper shakedown, but there were many unexpected issues in the winter tests and we lost a lot of track time. We did not have enough time to fully test everything,' Arai admits.

Lack of track time

That lack of time on track was clearly one of the biggest problems in the development of the RA615H, and many people have suggested that Honda perhaps should have developed its own power unit test bed, something Ferrari did back in 2013 in order to get more experience of running its F1 engine.

'Many people have asked about installing the RA615H into a Dallara Super Formula chassis,' Arai says. 'But you need space for the batteries, other electrical parts, which that car does not have. It's really not very easy to do in reality. The GT500 chassis was possible as it is bigger but again it would have been too much of a job to install it into the car, so we decided not to do that, it was too difficult to do.'

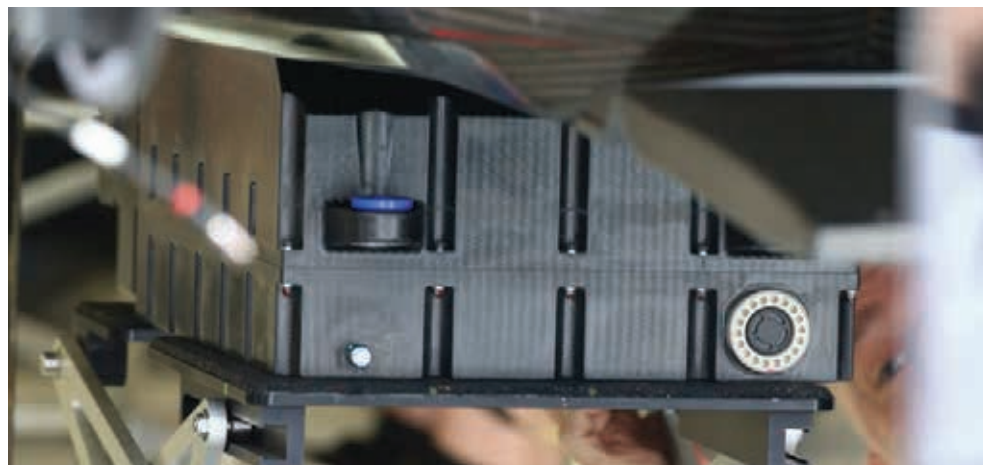

Above: The battery pack on the McLaren, with FIA seals, temperature strips and high-power connectors. This unit is mounted at the base of the MP4-30 chassis



Left: The McLaren MP4-29H test mule ran with additional ducting on the left-hand sidepod during early testing of the RA615H power unit

In all of the pre-season tests the McLaren Honda would frequently stop on track, and it was a trait that would continue right through the first half of the season with ten retirements (including two failures to start the race at all) in the first eight races. There were rumours that the only way that the Honda engine could be made to last the race was to run it at a reduced performance level, and even then technical failures were a regular occurrence.

But Arai claims that these rumours are simply not true: 'I have heard these stories but they are not true, we always use 100 per cent horsepower, but during those early races there were some small issues, many of them were related to heat. But we [had] already fixed those problems ahead of Barcelona, though now we still find many small troubles race by race.'

It's true that the performance of the McLaren-Honda has noticeably improved as the season has gone on, and this is largely related to the performance of the Honda power unit. It progressed enough for McLaren to secure its first points of the year with an eighth place finish at Monaco. 'We are now improving every race, improving horsepower, better drivability'

Arai enthuses. 'I think it is a great success story, but we have still not been on the podium, that is the next goal.'

Upgrade tokens

As part of that process Honda has used up two of the nine in-season performance upgrade tokens that it has been given to ensure parity with the other three manufacturers, who had 32 update tokens at the start of the season to use on their 2014 power units.

Beyond those tokens the only changes that can be made to a power unit are on the grounds of cost, safety or reliability, and Honda has made significant changes for the latter reason. This was particularly noticeable at the Spanish Grand Prix where the V6 engine was fitted with a new plenum. At the start of the season the RA615H uniquely featured a machined aluminium plenum, but that was in essence a reliability fix in itself, a result of some of the test failings.

'Barcelona was not really a new specification power unit, we originally tried to use a composite upper section of the plenum, but there were some failures in testing with cracking and poor sealing, so for the first races we used

an aluminium component for reliability. Now we have the composite part back as we have improved the manufacturing so it does not fail, but it is exactly the same design really. It was not a big update, it was just returning to the original design', Arai explains.

As the lower section still remains in aluminium it seems likely that there are more upgrades coming in this area. 'We are developing many new parts for the PU, but we don't have the complete plan yet to use the tokens and which tokens to use. But there is some new technology coming on the power unit, though, and you will see the impact when it is on the car', Arai adds.

Honda is adamant that it is in Formula 1 for the long haul, but it goes without saying that it needs to improve its performance very quickly. That said, there is a feeling among some in the Formula 1 paddock that the RA615H has yet to come close to showing its full potential, and that the concept could prove to be very potent indeed in the future. With seven performance tokens left to spend Honda could still move back to the front of the grid before long. Watch this space...



Honda's mystery new facility

To support its Formula 1 campaign Honda built a new facility in Milton Keynes, England to house its staff and test power units. Shared with Mugen Euro, the Mugen Technical Centre houses a number of dyno cells and offices, allowing both Honda and Mugen to conduct R&D work in Europe in conjunction with Honda's vast new R&D facility in Sakura City, Japan.

In early 2015 Honda filed a planning application in England to allow it to construct a large new facility behind the existing Mugen Technical Centre. The plans state that the new building will allow Honda to expand its operation in Formula 1 and allow it to develop new technologies in the UK. 'At

present, Honda's power units are solely used by the McLaren-Honda race team, but it is intended that they will become a key provider for multiple Formula 1 teams,' the document states. 'As a result it requires the new facility to not only service that demand but also conduct research and development in Europe.'

Development plan

The plans for the new building includes a number of CAD work stations, meeting rooms, truck bays, a machine shop, a staff canteen and a gym. Additionally a large area of the facility has been set aside for energy recovery system development. The ERS room is located next to a workshop containing small-scale engineering

workshop equipment such as lathe, milling machine, pillar drill and CNC machining centres. While the ERS R&D area will feature MGU dynos and other battery and electrical diagnostic equipment. 'The research and development specifically taking place is into state-of-the-art hybrid power technologies for Formula 1 racing cars, and this technology will filter into production vehicles', the planning document continues. 'The key to this growth is research and development of the technology and the proposal is a crucial element of this. It will provide significant employment opportunities for specialist engineers and support staff and will act as a further endorsement for Milton Keynes as a centre for cutting-edge engineering. The facility will initially generate approximately 35 full-time jobs, which will be a mixture of highly-skilled engineering positions and support staff. By 2018 it is expected the facility will directly employ approximately 65 staff with significant knock-on employment benefits both locally and nationally.'

The site for the new building has been acquired from the UK's state owned railway company, and was previously used as a storage area for track maintenance. However, Honda denies that there are any

immediate plans to recruit new staff and that the new facility is simply needed because it has run out of space in the Mugen building. 'Really this is just a warehouse to store our ERS, nothing more', Arai insists. 'The Mugen Technical Centre is tiny, we don't have any storage there. We use an old shipping container round the back of the building to store the ERS at the moment and it's not very good. So we need a bigger warehouse, we also need somewhere to keep the new motorhome. The current office is not good for trucks to come into either.'

New Honda teams

As for supplying multiple teams, Arai is very clear and re-iterates the comments he made to *Racecar Engineering* at the 2014 Japanese Grand Prix: 'We would like to have more than one team to supply, but right now nobody has come to me to ask for a power unit next year. Maybe now we have some points they will ask, I hope they do. If someone said to us, "give us a power unit", we have to consider it. FOM and FIA tell us that all power unit suppliers should supply multiple teams but the first year was a very difficult situation for us. Years two and year three we must think about it, but we have had no interest. Perhaps it's because we have not had any good results yet?'



Honda has filed plans to enlarge the Mugen Technical Centre in Milton Keynes

INTELLIGENCE CONNECTED



Flexible Hose and Fittings

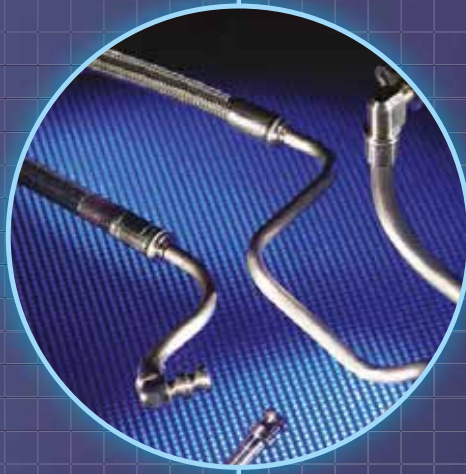

Rigid Lines and Swagel



Filtration

It's not by accident that, over the years, we have developed many successful partnerships with customers throughout motorsport – particularly in F1, endurance racing and WRC.

By applying intelligent analysis of their problems in the area of fluid transfer in high performance, high energy situations, we have established ourselves capable of providing innovative and cost-effective solutions.

SERVICES:

- 3D cad design service
- hose assembly
- hard-line manufacture
- cnc machining
- filtration design
- laser marking

PRODUCTS:

- **Titeflex smoothbore and convoluted hose products and fittings**
- **Swagel fittings and hard-line system solutions**
- **Pall Filtration systems**
- **CIRCOR Industria solenoid valves**

FHS

M O T O R R A C I N G

INTELLIGENT CONNECTIONS

Maintain system integrity, save weight, cut costs.
Make the connection now.

To find out how the quality of your own fluid transfer requirements can be improved, call our Technical Sales Team on

+44 (0) 1753 513080

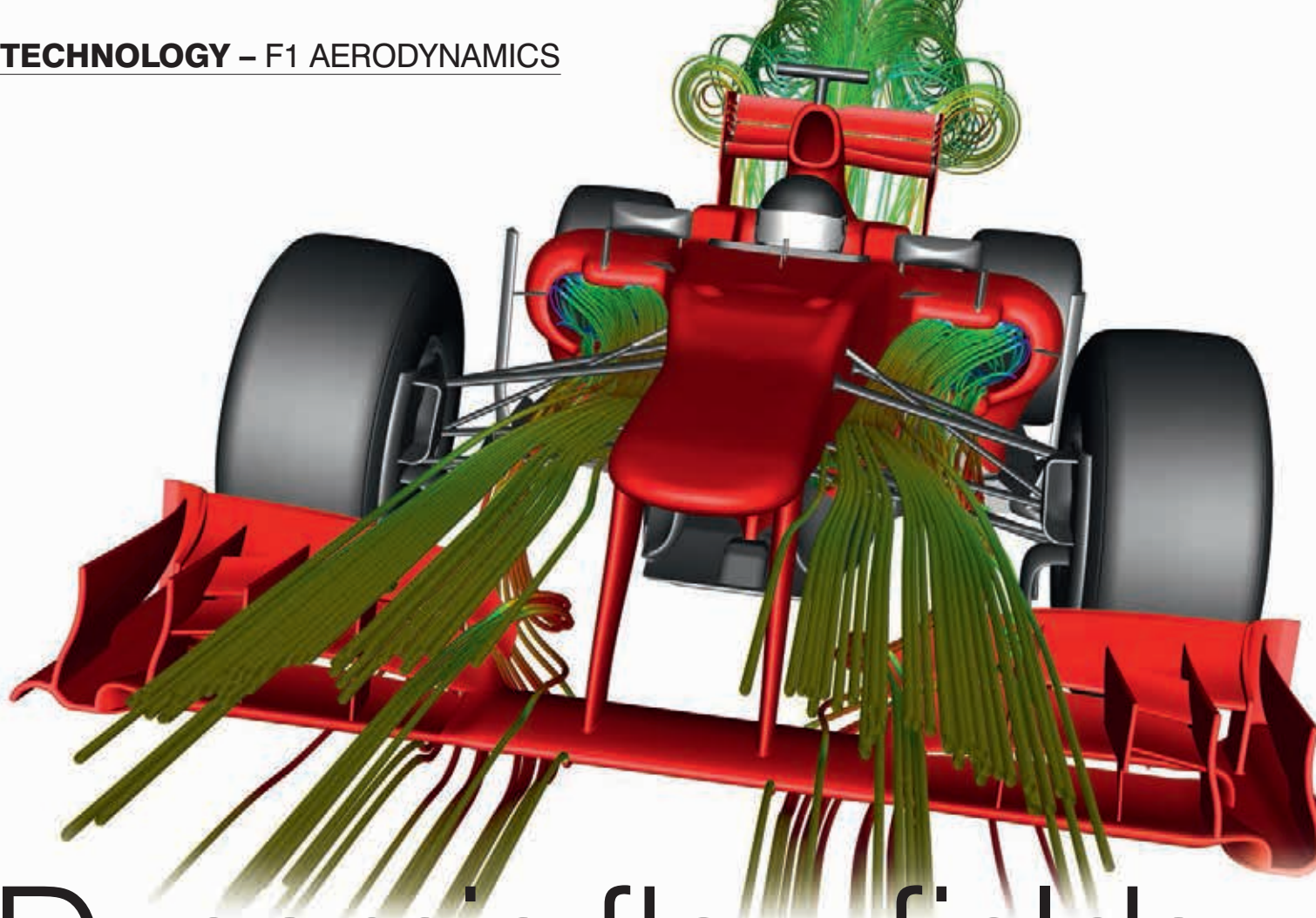

Dynamic flow fields

In the first of an exciting new, occasional series we delve into the real secrets of Formula 1 aerodynamics

By SIMON McBEATH

More often than not, discussion on the aerodynamics of top level racecars, especially Formula 1, is restricted to speculating about the function of particular devices or details. Occasionally a team will issue a generic CFD image that tells you little more than that the team does indeed use CFD to help develop its cars. And it's perfectly understandable that this is – normally – the limit of what we get to read and see because it's not in any of the teams' competitive interests to spill the beans openly and publicly. So it's all the more exciting that *Racecar Engineering* can now bring you exclusive insights into the aerodynamics of Formula 1 cars, courtesy of Dynamic Flow Solutions Ltd. The director of this aerodynamics consultancy, Miqdad Ali, has been creating 3D CAD models of F1 cars to

the pre-2009, pre-2014 and post-2014 technical regulations to run in CFD using OpenFOAM in order to share some illuminating aerodynamic insights with *Racecar Engineering*.

It should be understood that the models are necessarily generic and somewhat simplified. As Miqdad Ali says: 'We chose to create a model that is simplified in some regions and detailed in regions where it matters most for what we were trying to achieve. Brake ducts, for instance, are simplified; front and rear wings are detailed to a point. Other details that matter such as vortex generators have been incorporated so that a realistic representation of the flow can be produced.' So our simulations may not be directly comparable to the models that F1 teams create with large departments of aerodynamic engineers pounding away at their keyboards developing at

an almost microscopic level of detail. But a glimpse at the illustrations throughout this introductory article will tell you that they are very realistic-looking representations and that we will be able to learn a lot about the complexity of the flow fields and the management thereof that goes into generating aerodynamic performance on these cars. We will also, in future

issues, be able to compare data on models to different rule sets, and investigate specific areas of interest to gain an improved understanding of what the teams are up against. In this first instalment we will start exploring what the first few runs of a 2013 F1 model revealed and derive further insight with comments from Miqdad Ali (MA) himself.

Table 1: basic CFD info

OpenFOAM, steady state RANS solver
Hex and split-hex mesh, 38 million cells (half car)
Inlet speed 67m/s (150mph)
Moving ground and rotating wheels
SST k-omega turbulence model
Engine inlet and exhaust flows modelled at 17,000rpm equivalent

Table 2: baseline coefficients at representative ground clearance

Configuration	CD	CL	L/D
15f 72r	1.174	-3.476	-2.961

Figure 1

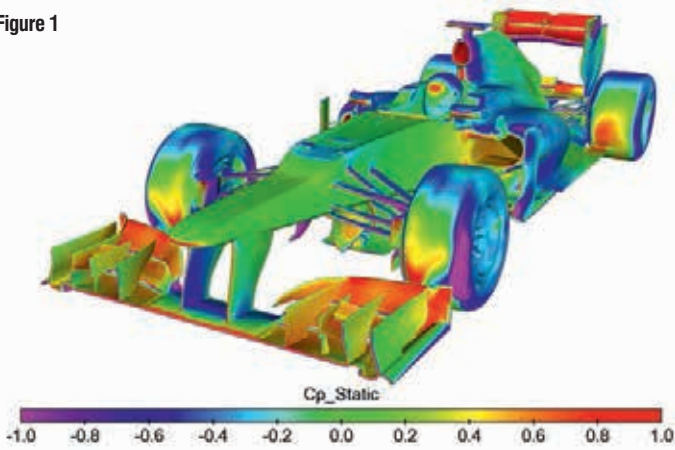

Figure 2

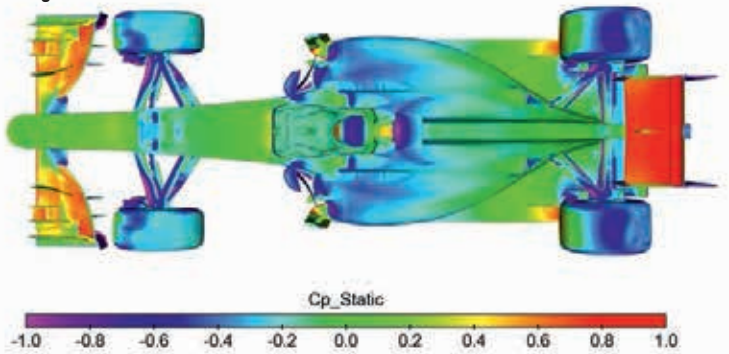

Figure 3

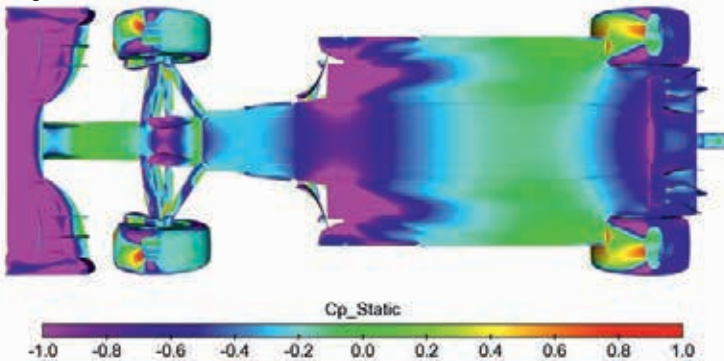
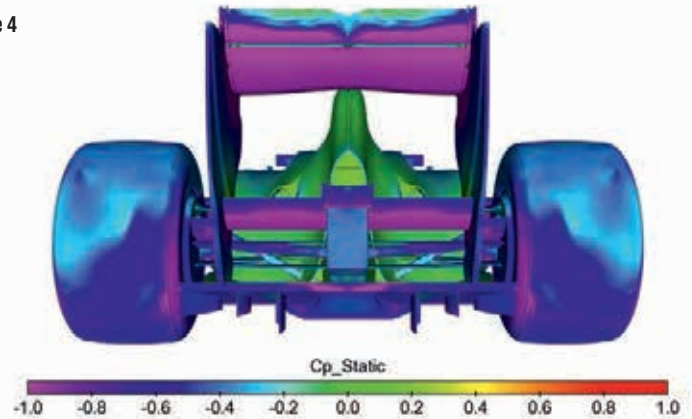

Figure 4



Figures 1 to 4: Static pressure coefficients on the surfaces of the 2013 phase 1 model reveal the sources of lift, downforce and drag

Initial runs

Having ascertained that the CAD model meshed and solved satisfactorily (see **Table 1** for the basic CFD parameters), one of the first comments arising from examination of the front to rear aerodynamic balance on the model was the importance of chassis rake in allowing the restricted diffuser to work effectively, something echoed in side views of pre-2014 and current cars. The initial target was to try to achieve between 45 per cent and 48 per cent of the total downforce at the front of the car in order to be representative of pre-2014 F1 car static weight balance, and although the first few runs illustrated here were still a little short of that in spite of significant rake being applied to the car, MA was confident that further attention to the diffuser in particular and modification of the wheelbase would generate more underbody downforce and enable balance, total downforce and efficiency improvements.

Table 2 shows the first set of data on the car at a representative

ground clearance, indicated here as 15f72r – these being measurements in millimetres at the intersection of the reference plane (chassis bottom minus the ‘plank’) and the front and rear axle lines. We will revisit the effects of reductions in ground clearance later in this article but for now, let’s just study the first set of data and ponder the sources of the forces.

The initial percentage front value was fairly close to 50 per cent, a little on the high side, but considering this was just a handful of runs into the model’s development it was in the right ballpark. Can we know if the coefficients and L/D were also of the right order? Well, we have evaluated two F1 cars (the Benetton B199 and Honda RA107, both built to earlier rule sets) in the MIRA full-scale wind tunnel for our Aerobytes column and they had drag coefficient (CD) values of 1.000 and 1.046 respectively in the baseline configurations they were tested in, but with a reference frontal area of 1.2m² (producing CD.A values of about 1.2) compared to the reference value in our CFD simulations

of 1.0m². So a CD.A value of 1.164 on our 2013 model’s first runs was very similar to those earlier cars.

Determining whether the CL value on our 2013 model was of the right order cannot be done by comparison with the MIRA data because of that wind tunnel’s fixed floor and stationary wheels, which are known to significantly underestimate the lift coefficients of ground effect cars. In the absence of recent and complete data, MA added (from his own knowledge base) that L/D for 2012 front running cars for instance ranged from 3.5 to 4.0. Smaller teams were anywhere between 3.1 and 3.5. So there was good cause to think our coefficients were pretty realistic, a really good result considering that no development had as yet been done.

Feeling the pressure

Accepting then that even at this early stage we were seeing some pretty representative data, let’s look at some visualisations to get a better idea of the overall picture and of the complexity in the details.

Figures 1 to 4 show the surface pressure distributions and allows us to see where drag and lift were being generated. Colours from red through to yellow are regions where the surface pressures were high, and from green through to pink are regions where surface pressures were low.

Starting with **Figure 1**, at the front of the car the front wing’s upper surfaces showed generally increased pressure coefficients, with the steepest surfaces showing the highest pressures. Clearly there are vertical and horizontal force components from pressure differentials on such forward facing inclined surfaces, contributing to both downforce and drag. The central ‘neutral’ section (which is defined in the rules) between the wing supports shows reduced pressure, but, as **Figure 3** shows, the pressure coefficient on the underside was generally lower still, thanks to ground effect, so this section would still have been contributing net downforce.

Moving aft to the front tyres, and we see a pretty complex pattern of

Due to the restrictions on underbodies in modern F1 rules, downforce generation has to be done by generating and managing vortices

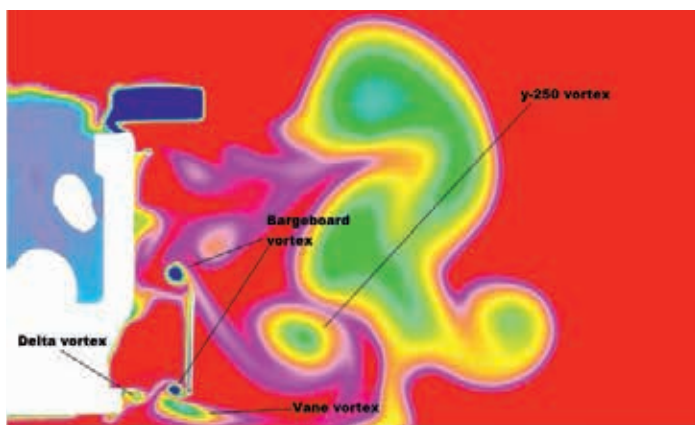

Figure 5: Transverse total pressure slice showing various vortices initiated by the front wing, the under-chassis vane and the bargeboard

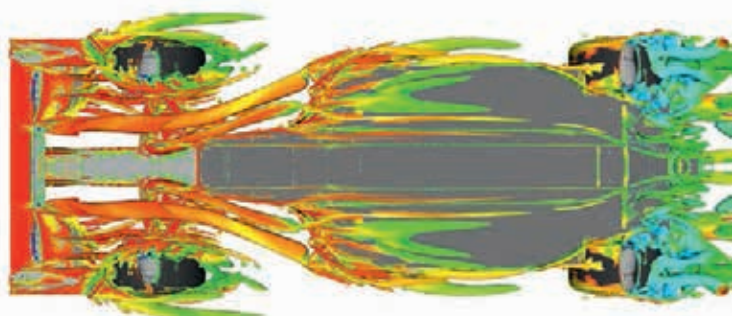

Figure 7: Bottom view of vortices reveals yet more flow complexity

pressure distributions. The red region highlights where air was essentially running directly into the tyre, but the shape and size of this area is smaller than it would be if there were no wing in front of it because, as MA put it 'a combination of [end plate] footplate vortex, gutter vortex and the separation vortex from the rear of the endplate is managing the flow efficiently around the front tyre'. The top of the front tyres showed reduced pressure, no surprise over a convex surface, and this in part explains why the front tyres generated lift, along with the slight upward component

upper surfaces, which is indicative of increments of lift too.

Moving to the top of the chassis, the pressure along the majority of the forward chassis was essentially 'neutral' (green), with minor changes on the step from the nose to the chassis itself. The turning vanes under the forward chassis look like areas of interest and we will return to those later as well.

Continuing further aft on the car's upper surfaces we can see reduced pressure over the sidepods, indicating an increment of lift here before we get to the rear 'tyre shelf' region, where

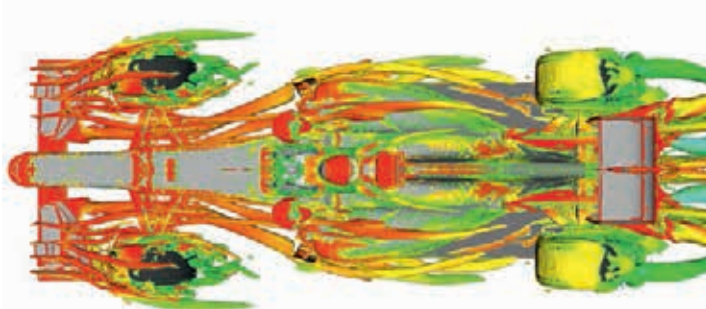

Figure 6: 'Lambda-2 iso-surface' plot shows the mass of vortices generated from the top

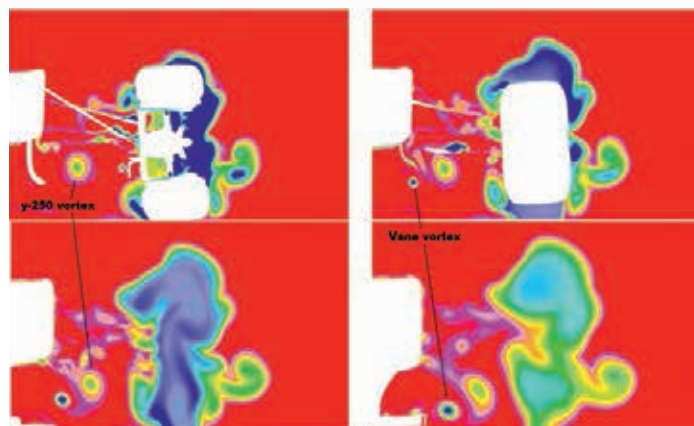

Figure 8: Transverse slices plotting total pressure at the front wheel centre (top left) and three successive steps to the rear show the 'y-250' and 'vane' vortices moving towards the ground

Figure 2 makes it more obvious where the sources of downforce and lift are on the upper surfaces. More striking perhaps is Figure 3, showing the bottom view of the static pressure coefficients, and here we see where the majority of the car's downforce was generated, excepting that we cannot see the rear wing's underside at all in this view. Starting at the front again it is clear that the whole of the front wing's underside was at much reduced pressure (the pressure coefficients will be a lot less than -1, the restricted pressure range is used in these images for greater

Finally on this static pressure tour, Figure 4 shows that the rear wing's underside did indeed develop much reduced pressures, as did the lower beam wing (absent on 2015 cars) and clearly the drag of the rear tyres was also about the reduced pressure on their rearward facing surfaces too.

Vortex generation

Due to the restrictions on underbodies in the modern F1 rules, downforce generation has to be done in large part by generating and managing vortices. This not only directly utilises the low static

The forward faces of the rear tyres clearly show large areas at raised pressures, and they are a major drag contributor

from the raised pressure region on the lower front part of the front tyres. The blue and pink region on the outer, forward part of the front tyre wall shows much reduced pressures and in part this was due to the above mentioned wing tip vortices, with their low pressure cores, encountering the tyres here, as well as the general acceleration of the flow field around the tyre's outer edge. Inboard of the tyres, the front suspension links all showed reduced pressure on their

there are also Gurneys on the trailing edge, which saw a region of raised pressure, and hence downforce, ahead of the rear tyres. The forward faces of the rear tyres clearly show large areas at raised pressure, and it is well known that they are a major drag contributor; again there was raised pressure on top of the rear tyres, indicating probable lift generation. Finally the rear wing obviously saw increased pressure on its upper surface, generating some of its downforce and drag.

clarity). Again we can see a local area of interest in between the turning vanes in line with the inboard front suspension mounts, and clearly some downforce was generated here, although this was probably not the primary reason for these vanes. The region under the front splitter was at reduced pressure but the front section of the main underbody was at even lower pressure, as was the area from just ahead of the diffuser transition to the trailing edge of the diffuser itself.

pressures created in the cores of vortices but also involves the use of vortex generators (and other devices) to manage and steer the flows in other beneficial ways. An example of the former is the use of bargeboards, which generate vortices from their top and bottom edges, and those generated by the bottom edges are used to enhance the low pressure in the forward underbody. And a much discussed example of the latter is the use of the 'y-250' vortex, generated

Table 3 – the distribution of downforce on our 2013 model and on the 2009 Sauber

	2013 model downforce, %	2009 Sauber downforce, %
Front wing assembly	39.0	29.0
Front wheels, suspension, brake ducts	-2.4	-1.0
Chassis, bodywork	-9.9	-8.0
Floor and diffuser	46.3	52.0
Rear wheels, suspension, brake ducts	0.1	3.0
Rear wing assembly	27.0	25.0

Table 5 – the effects of ride height reductions

Configuration	CD	CL	L/D
25f 82r	1.164	-3.188	-2.738
20f 77r	1.155	-3.356	2.905
15f 72r	1.174	-3.476	2.961
10f 67r	1.154	-3.524	3.053

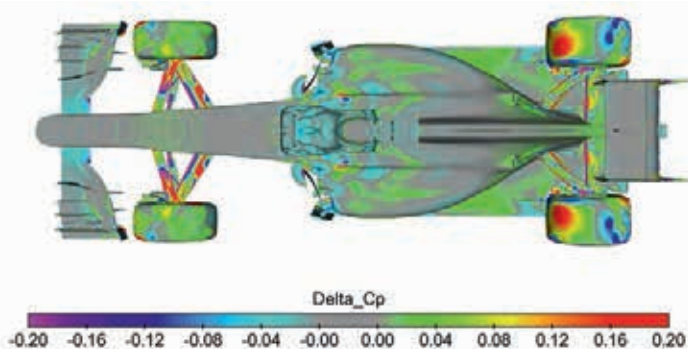

Figure 9: Upper surface static pressure changes are shown as the result of the lowering the ride height by 15mm

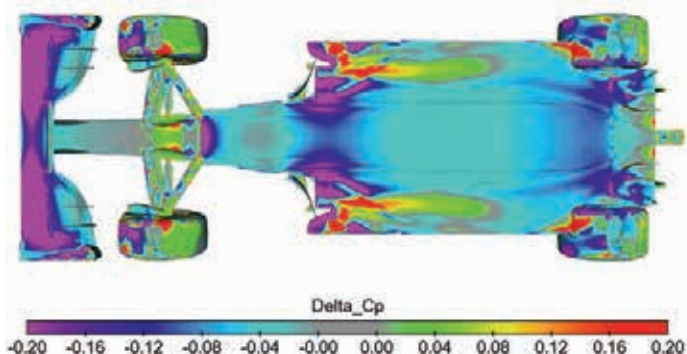

Figure 10: Lower surface static pressure changes are shown as the result of lowering the ride height by 15mm

at the intersection of the mandatory 500mm wide neutral central section of the front wing's main element and the potent multi-element sections outboard of that (this intersection, in the global coordinate scheme, is on the xz plane at y = 250mm, hence the name). This potent vortex can be used to turn the front wheel wake outboard so it does not impinge on, and adversely affect, the airflow entering the underbody – see **Figure 5**.

Figures 6 and 7 are 'lambda 2 iso-surface' plots coloured by total

pressure (equivalent to total energy, so red is high energy, blue is low energy) and are a means of visualising coherent vortex structures in the flow. The first thing to leap out of such plots is the amazing complexity in the overall flow field. Looking more closely, the y-250 vortex is the single biggest vortex generated by the front wing, and although it was initially perceived as a nuisance when wings with the central neutral section were introduced for 2009, the teams soon learned how to manage and exploit it.

Table 4 – the distribution of drag on our 2013 model and on the 2009 Sauber

	2013 model drag, %	2009 Sauber drag, %
Front wing assembly	24.3	20.0
Front wheels, suspension, brake ducts	5.7	10.0
Chassis, bodywork	12.6	10.0
Floor and diffuser	3.9	13.0
Rear wheels, suspension, brake ducts	24.1	17.0
Rear wing assembly	29.4	30.0

Table 6 – downforce distribution values at four ride heights, as percentages of the total

	Static	Down 5mm	Down 10mm	Down 15mm
Front wing assembly	39.6	38.7	38.4	39.0
Front wheels, suspension, brake ducts	-3.7	-3.4	-3.0	-2.4
Chassis, bodywork	-10.7	-10.1	-9.7	-9.9
Floor and diffuser	45.0	46.5	45.8	46.3
Rear wheels, suspension, brake ducts	-0.8	-0.5	0.9	0.1
Rear wing assembly	30.5	28.7	27.7	27.0

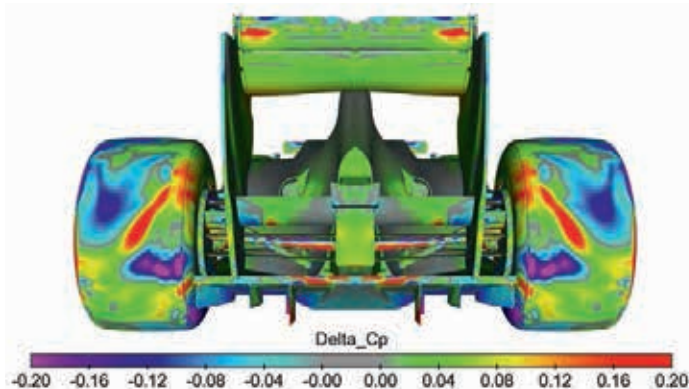

Figure 11: Rear surface static pressure changes are shown as the result of lowering the ride height by 15mm

Another potent vortex was generated by the vanes on the chassis underside, between the front suspension connections. This area was mentioned earlier as one where some downforce was generated between the vanes. But in **Figures 5 and 6** it can clearly be seen that a potent vortex formed on either side and headed towards the bargeboard and underbody. What is less clear in these images, but which becomes apparent in **Figure 8**, showing, from the front, transverse total pressure slices through the front wheel and at two further steps downstream, is that the vortices from these vanes induced some downwash ahead of the underbody entrance. The vane vortex and the y-250 vortex can be seen getting closer to the ground in each of

the three downstream steps from left to right in **Figure 7**. This downwash helps to increase the mass flow into the underbody to increase downforce. Vortex management thus plays a large role in F1 aerodynamics, and we shall revisit this principal in future issues.

Force distributions

One of the incredibly useful facilities of CFD is the ability to calculate separately the forces on individual components. **Tables 3 and 4** show the distribution of the forces on the major groups of components of our 2013 model (at 10f67r) compared with a published set of data on the 2009 Sauber (in a paper referenced at the end of this article). The latter were derived from a bar chart and are thus approximate, but in any case would

CFD provides the ability to calculate separately the forces on components

Another trend was the reduction in lift generated by the front wheels/suspension/brake duct sub-assembly with decreasing ride-height

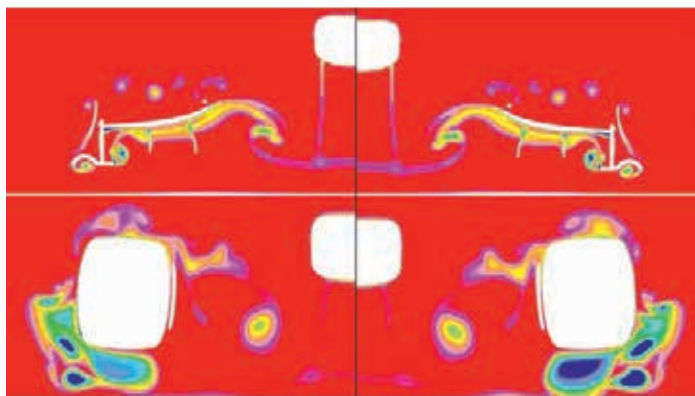

Figure 12: Transverse total pressure slices at the front wing and just downstream of it, at two ride heights (lower on the right). Note the differences in total pressure in front of the front wheel

clearly depend on the car's exact configuration so are only indicative. There are some obvious differences but also some broad similarities between the force distributions on these two cars. Assuming exactly the same component surfaces were grouped together, one of the main differences in the applicable rule sets was that the 2009 cars were permitted to use more potent diffusers. Thus it would be expected that the 2009 car would generate a greater proportion of its total downforce with its floor and

diffuser, which it did. MA added 'what should also be noted is that in 2009 the cars still had the wider front tyres, which produced a bigger proportion of the drag compared to 2013 tyres, which were narrower'.

Changing ride heights

We'll round off this introduction to our F1 CFD insight with a look at the changes arising from ride height reductions on the phase one 2013 model. Front and rear ride heights were reduced in three increments

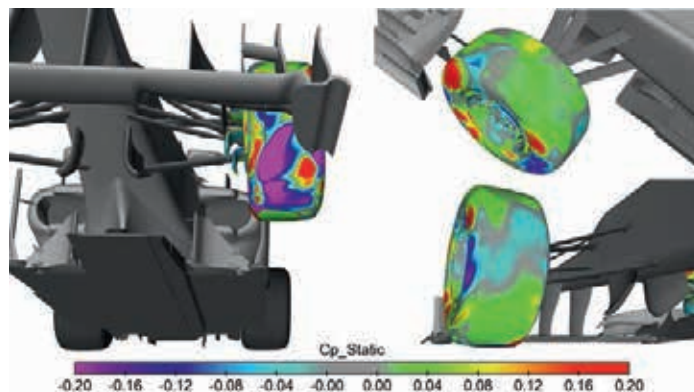

Figure 13: Three views of the changes in static pressure on the front wheel as the result of lowering ride height by 15mm. Compare the reduced static pressure on the front of the front wheel with the reduced total pressure encountering the wheel at the lower ride height in Figure 11

of 5mm, and these coefficients are shown in **Table 5**.

Broadly, the changes to drag were quite small and variable with decreasing ground clearance. Total downforce increased with each ground clearance reduction, with the gains tailing off. The front downforce gains were more or less linear, but the gains at the rear tailed off over the first two height reductions and then reversed at the last height reduction, suggesting perhaps that diffuser performance was beginning to decline, although as we shall see shortly this was not the only reason. This also saw the balance shift forwards at the lowest ride height, but as MA remarked 'we will investigate this properly once the car is developed to produce the right numbers both in terms of L/D and balance – but the initial observations here are indicative of what to expect'.

By looking at the changes in the force distributions at the four ride heights we get **Table 6**, which shows the downforce distribution values on the major component groups.

As well as some of the more obvious and expected changes, which **Figures 9 to 11** help visualise, there were two detail changes that are worth looking at in **Table 5**. First, and initially the most perplexing, was the decline in rear wing downforce (in absolute as well as relative terms) with decreasing ride height, which we can also see in **Figure 11** as an increase in the static pressure on the wing's underside from the highest to the lowest ride heights. It wasn't immediately clear why rear wing

downforce should reduce with reducing ride height. However, the front wing has a profound effect on the performance of every item downstream, and in this case it was thought that the increase in the front wing's ground effect-aided downforce may have either modified the effective angle of attack of the rear wing and/or reduced the total pressure in the flow to the rear wing.

Another interesting trend was the reduction in lift generated by the front wheels/suspension/brake duct sub-assembly with decreasing ride height. First, it's worth noting that the suspension links themselves, which we mentioned earlier could be seen to generate lift in the static pressure plots in **Figures 1** and **2**, create some downwash to parts further downstream, mitigating to an extent the upwash that is generated by the front wing. And the changes we saw in the lift created by the wheels and suspension as ride height is reduced also arise from changes to the flow emerging from the front wing. See **Figures 12** and **13**.

Summary

This first model iteration has already enabled unprecedented insights into F1 aerodynamics for those of us who have not previously been intimately involved in this subject matter. Further developments and configuration changes will yield more fascinating features in future issues.

Reference: *Aerodynamics and aerodynamic research in Formula 1*, Toet, W., *The Aeronautical Journal*, January 2013, Vol. 117, No. 1187

Dynamic Flow Solutions

Dynamic Flow Solutions Ltd is an aerodynamics consultancy headed up by director Miqdad Ali, ex-MIRA aerodynamicist, who carried out the CFD simulations showcased in this article.

Miqdad Ali has performed design, development, simulation and test work at the highest levels of professional motorsport, from junior formula cars to World and British touring cars, Le Mans prototypes, up through to Formula 1 and Land Speed Records. *Racecar Engineering* readers may recall his contribution to the 'CDG wing' discussions in our June 2007 (V17N6) issue.

With significant experience within the automotive sector too he has also provided aerodynamic solutions to a number of major auto manufacturers, and has been involved in various research activities involving transient aerodynamics, fluid structure interaction, vortex flows and flow visualisation. He has also worked in

the hydrodynamic design of ship hull forms, warship aerodynamics, HVAC and thermal management, gas dispersion and multiphase flows. **Contact:** miqdad.ali@dynamic-flow.co.uk

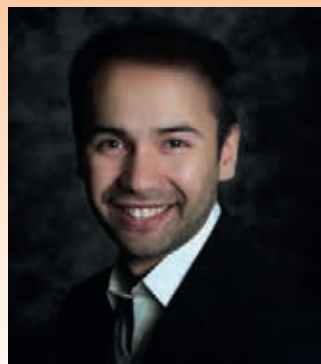

Miqdad Ali, director of Dynamic Flow Solutions Ltd





McLAREN: SYNONYMOUS
WITH WORLD CLASS
QUALITY AND DESIGN;
**CHAMPIONSHIP WINNING
PERFORMANCE AND
RELIABILITY**

Find out more about our high performance products and bespoke solutions that can fulfil the most specialised of functions by visiting: www.mclaren.com/appliedtechnologies/products

Dynamic flow fields

Racecar Engineering uncovers more Formula 1 aerodynamic secrets courtesy of the colourful world of CFD

By **SIMON McBEATH**

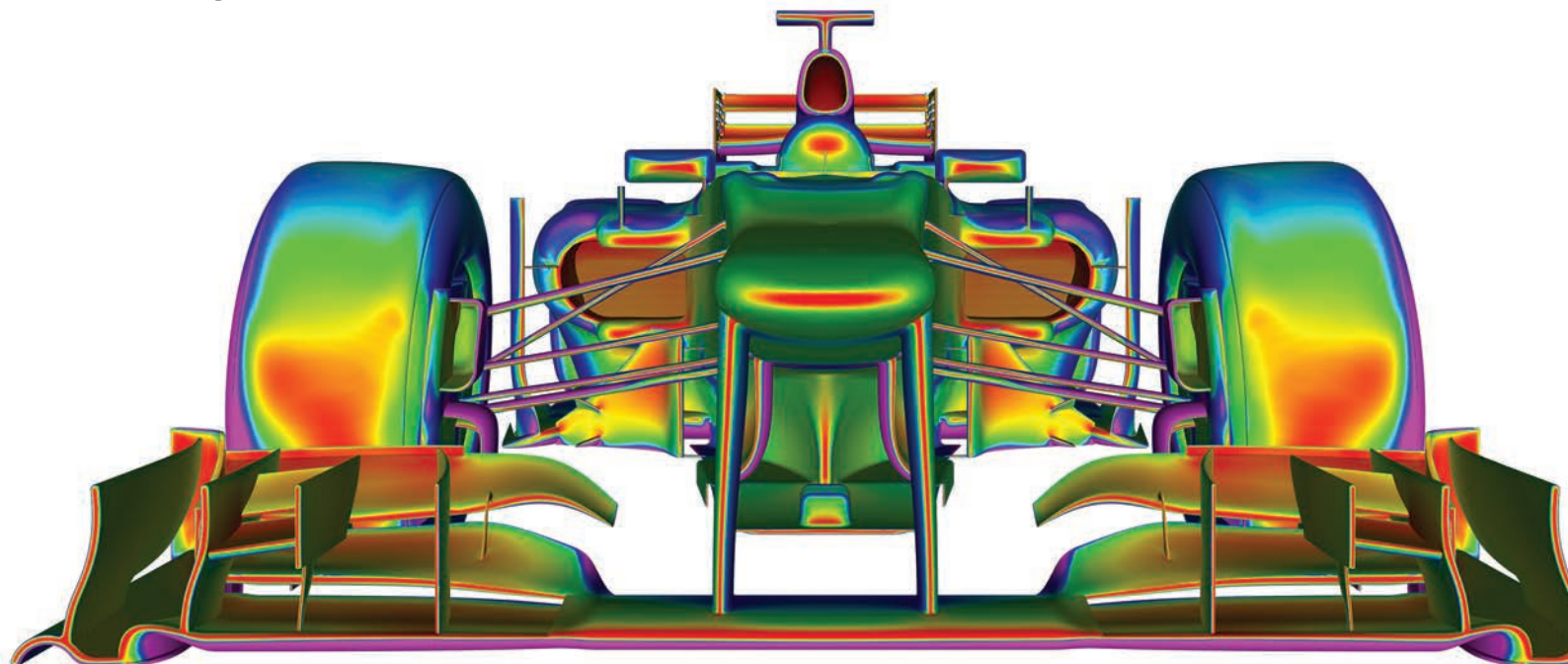

Continuing our foray into the details of Formula 1 aerodynamics, Dynamic Flow Solutions and its director Miqdad Ali have once again been running OpenFOAM CFD simulations on a highly realistic F1 model to provide *Racecar Engineering* readers with more unique and exclusive insights. In this instalment we look at major and minor modifications that have significant – and ‘global’ – effects, while we also visualise and quantify some of the side effects of deploying the Drag Reduction System (DRS).

In our first instalment of this exciting occasional series (RE V25N7) we examined our 2013 regulations

baseline model to see where downforce and drag were generated, and looked at how the generation and management of vortices was (and still is) an important means of generating downforce with regulation-restricted underbodies. Then we examined how ride height changes affected the aerodynamic coefficients.

We also made some comparisons with public domain data on a 2009 Sauber F1 car, which highlighted some areas where ‘our’ model could be improved, as Miqdad Ali, (‘MA’) explains: ‘We looked at body forces on individual component segments such as front wing, rear wing, body, floor and diffuser and so on, and compared those to a 2009 Sauber F1 car on

the same segments. The data on the baseline model at representative ride heights showed that more downforce could be had from the underfloor region, which warranted modification of the diffuser to work the underfloor better. Also the extension of the wheelbase should be evaluated; gaining more floor area should improve the L/D of the car. We were targeting -3.5 as our L/D and hoping the changes we would make would help us get there.

‘Furthermore, the rear tyres on the Sauber model generated a lot less lift because the flow around the contact patches close to the diffuser was accelerating faster, reducing the pressure on the tyres’ lower surfaces

and thus reducing lift as a result. This could only have happened if their diffuser was working better, another indicator that our diffuser needed improvement! We also wanted to make sure that we could get a reasonable balance since the baseline assessment showed forward-biased downforce generation that was not in line with the static weight distribution.’

For reference the basic CFD parameters are given in **Table 1** and the baseline aerodynamic coefficients found on the model at the start of this project are given in **Table 2**.

Although the downforce and drag coefficients were felt to be reasonable for a first iteration, balance (%front) was too far forwards with

The first configuration change made to the CAD model for this instalment was to lengthen the car’s wheelbase by 200mm

Table 1 – Basic CFD parameters

OpenFOAM, steady state RANS solver
Hex and split-hex mesh, 38 million cells (half car)
Inlet speed 67m/s (150mph)
Moving ground and rotating wheels
SST k-omega turbulence model
Engine inlet and exhaust flows modelled at 17,000rpm equivalent

Table 2 – Baseline coefficients at representative ride height; '15f 72r' refers to 15mm front ride height and 72mm rear ride height (measured between the ground and the reference plane at the axle lines)

Configuration	CD	CL	L/D	%front
15f 72r	1.174	-3.476	-2.961	52.80%

Table 3 – Coefficients at representative ride height with 200mm longer wheelbase

Configuration	CD	CL	L/D	%front
15f 72r +200mm W/B	1.193	-3.640	-3.051	51.46%

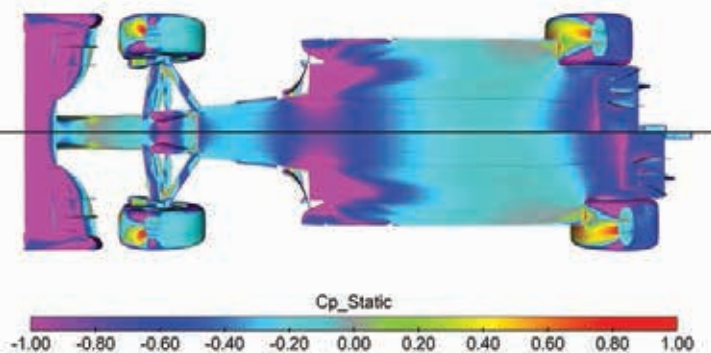
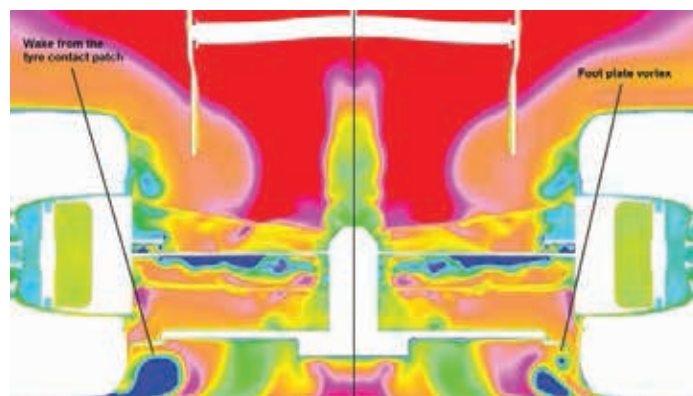
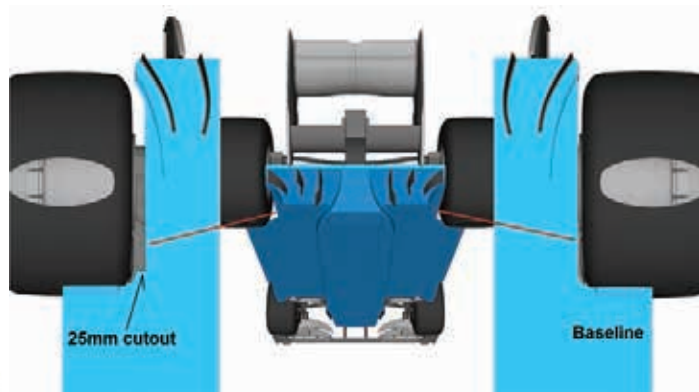
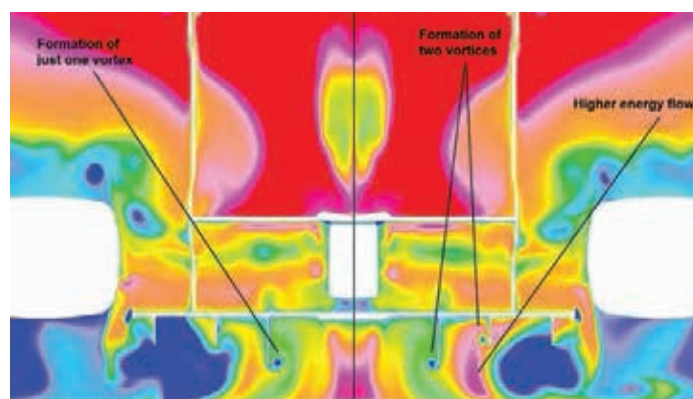
**Figure 1: Underside surface pressures with original and 200mm extended wheelbase****Figure 3: Transverse slice at the rear axle line (where the diffuser starts) showing total pressure (or energy) in the flow – footplate slot is in the right hand side image****Figure 2: A slot in the diffuser footplate produced significant changes in coefficients****Figure 4: Total pressure slice part way along diffuser showing the higher energy flow**

respect to the expected static weight distribution, and so improving that as well as overall aerodynamic performance were the priorities for this second phase of work.

Longer wheelbase

The first configuration change MA made to the CAD model for this instalment was to lengthen the car's wheelbase by 200mm. This was achieved by stretching the centre section just aft of the roll hoop so the whole rear end was moved back by 200mm, otherwise the front half and rear end were left unmodified. The data is shown in **Table 3**, and a comparative plot of the underside surface pressures is shown in

Figure 1. MA commented: 'As expected the downforce went up because of the bigger floor area, and the balance shifted towards the rear.' Indeed, close inspection of **Figure 1** reveals that not only did the 'suction peak' at the diffuser transition move aft relative to the rest of the car, but also somewhat lower pressures were obtained in parts of the diffuser. Downforce increased by 4.7 per cent compared to the baseline model, and L/D went up by 3.0 per cent with a 1.5 per cent (absolute) rearwards shift in aerodynamic balance (%front).

MA remarked: 'I realised that the floor could generate more downforce so I investigated the diffuser area. A few transverse slices of total pressure

coefficient close to the rear tyre contact patch area revealed that the flow from the tyre contact separation was spilling into the diffuser region and reducing its effective working area. If the effect of tyre contact 'spillage' could be reduced, the diffuser would work better and increase mass flow under the whole car, so increasing downforce as a result. One way to do this is by exhaust blowing.

'In 2012 the F1 teams used to blow exhaust gases into that area to seal the diffuser from tyre spillage, so improving floor performance. The FIA banned that so teams resorted to the Coanda exhaust approach where they aimed the exhaust gases so they

would be roughly in that area and produce similar results. It worked, but not as well as the full blown concept. Either way, I decided to use a slightly different approach and look at the Coanda effect at a later date.'

MA's chosen modification was to cut a 25mm slot out of the footplate along the outer edges of the diffuser, just inboard of the rear tyres (**Figure 2**). MA said: 'The idea of the slot was to allow some high energy air into the affected region. The pressure difference between the diffuser (low pressure) and above the footplate (high pressure) would create a vortex which would interact with the tyre contact separation and reduce its effect on the diffuser area.'

'As expected the downforce went up because of the bigger floor area, and the balance shifted towards the rear'

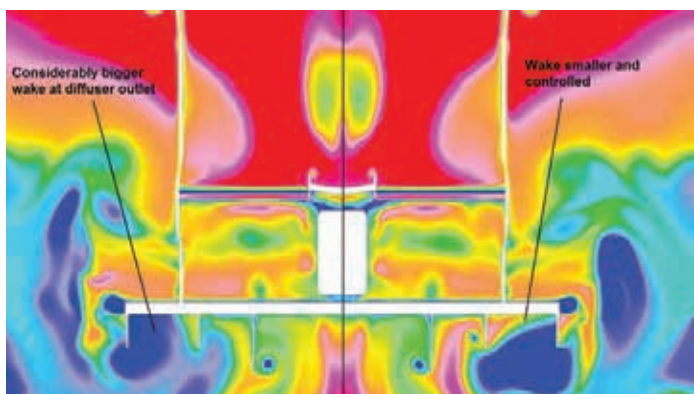

Figure 5: Total pressure slice at the diffuser exit

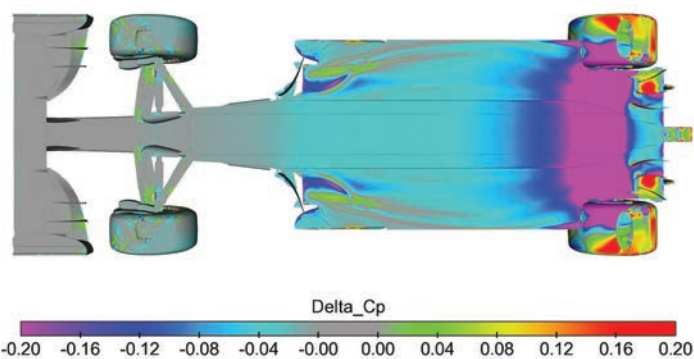

Figure 6: Delta_Cp plot shows how the underside pressures changed with the diffuser footplate slot – note just how far upstream the effects extended

Table 4 – Coefficients after the diffuser footplate modification, at two ride heights				
Configuration	CD	CL	L/D	%front
15f 72r + 200mm W/B + diffuser footplate mod	1.171	-3.940	-3.360	48.83%
10f 67r + 200mm W/B + diffuser footplate mod	1.161	-4.046	-3.480	49.38%

Figure 3 is a transverse slice at the rear axle line (where the diffuser starts) showing total pressure (or energy), and we can see this mechanism at work. A vortex has indeed rolled into the gap created by the slot (right hand side of the image) and has already reduced the size of the wake from the tyre contact patch. And just inboard of the reduced tyre contact patch wake the area of higher energy air (red and pink) has increased. Moving downstream to roughly in line with the back of the rear tyres, Figure 4 shows that the area of higher energy air carries on into the diffuser. Furthermore, the energy in this region is now sufficient that a pair of vortices has formed from the diffuser turning vanes, which in turn will help reduce the pressure

within the diffuser. And at the diffuser exit (Figure 5) we can see that the reduced tyre wake and increased higher energy region have persisted through the diffuser.

MA says: 'This shows that the energy in the diffuser is slightly higher and as a result downforce has gone up significantly. This small change increased downforce by around eight per cent from the previous run and by 13 per cent compared to the baseline, a massive gain by F1 standards. You can see from Figure 6 that there is significant pressure reduction in the diffuser area as a result, meaning the vortex seal was working. More work can be done to improve that area but for now we know how the concept works! Also, the rest of the floor area also worked better after the footplate

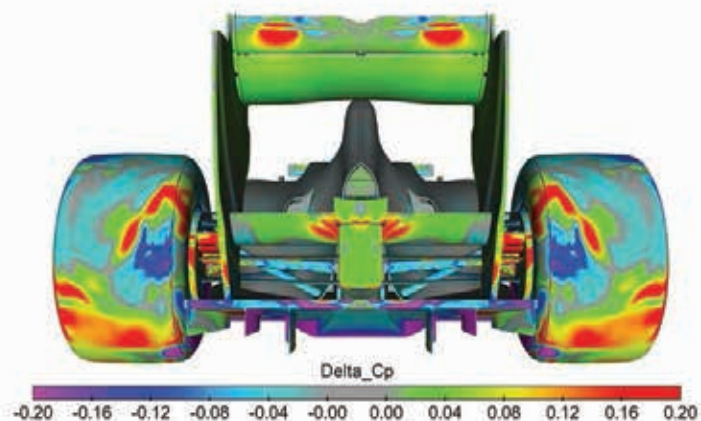

Figure 7: Rear delta_Cp view shows the changes on wing assembly and tyres which are caused by the footplate slot

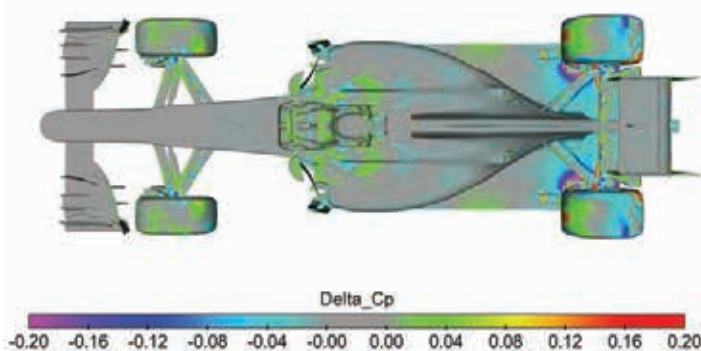

Figure 8: Upper surface delta_Cp plot shows the extent of the changes caused by the footplate slot modification. Both 7 and 8 show that what you change on front affects rear

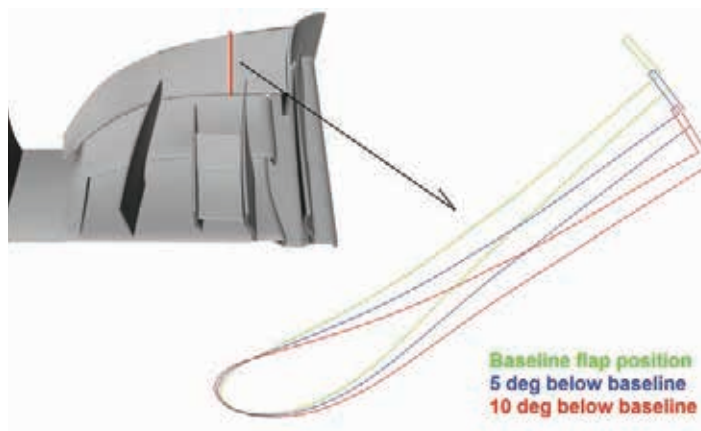

Figure 9: Front flap adjustments were in 5-degree increments

modification. This change moved the balance rearwards, which was still heading to the right direction. At this stage we were at around 48 per cent to 49 per cent front and we were aiming for 44 to 47 per cent.'

MA continued: 'The footplate modification not only improved the floor significantly, the resulting changed flows have also interacted differently with the rear tyre contact patch area, reducing the pressure and rear tyre lift as a result, as also seen in

Figure 6. Other changes can be seen on the rear wing, top surfaces of the car, etc. – illustrating the fact that the car works as a system and what you change in the rear really affects the front and vice versa (Figures 7 and 8).'

Table 4 shows the coefficients and balance with the footplate modification. Compare this table with Tables 2 and 3 to see the true extent of these changes. The CL exceeded -4.0 at the lower ride height and the L/D was almost -3.5.

'Energy in the diffuser is slightly higher and as a result downforce has gone up significantly. This small change increased it by eight per cent'

Table 5 – The effects of changing front flap angle

Configuration	Front flap	CD	CL	L/D	%front
15f 72r	Baseline	1.171	-3.940	-3.360	48.83%
15f 72r	-5deg	1.166	-3.945	-3.380	47.48%
15f 72r	-10deg	1.173	-3.892	-3.320	44.63%
10f 67r	Baseline	1.161	-4.046	-3.480	49.38%
10f 67r	-5deg	1.165	-3.988	-3.420	47.89%
10f 67r	-10deg	1.159	-3.931	-3.390	45.00%

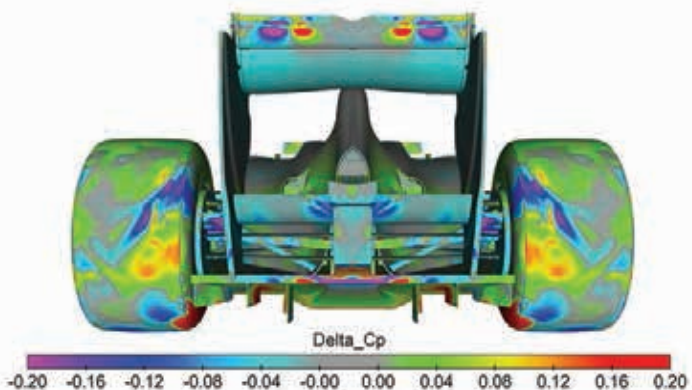

Figure 10: With a 5-degree front flap reduction the rear wing and beam wing worked slightly better, with more suction (pale blue) on the lower surfaces

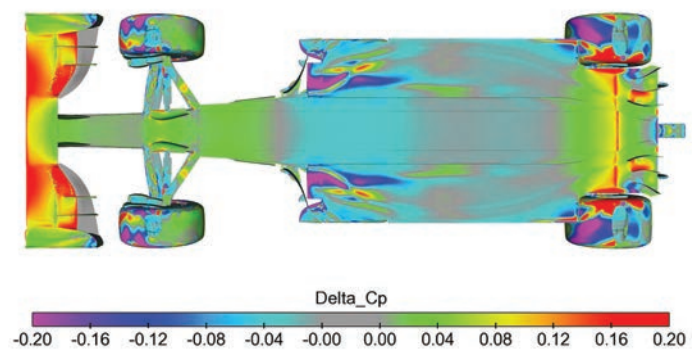

Figure 11: The changes to underside pressures with a 5-degree front flap reduction differed from ...

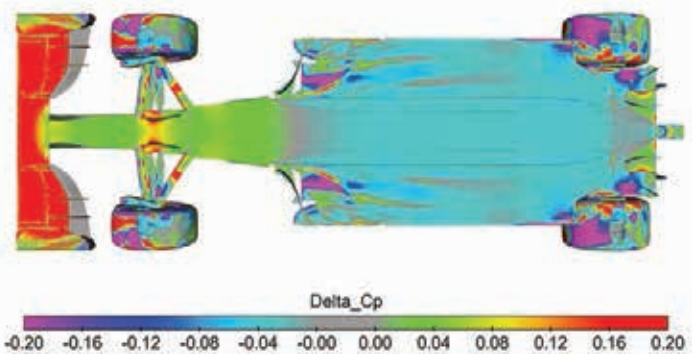

Figure 12: ... the changes to underside pressures with 10-degree front flap reduction

Balance changing

Probably the most obvious means of altering the balance would be to alter the front wing flap angle. Yet, we saw in our Aerobytes studies on the 2007 Honda F1 car back in 2012, adjusting the front flaps does more than alter the downforce generated

by the front wing. It was clear from that wind tunnel exercise that other things changed as front flap angle was adjusted, but what we couldn't tell in the wind tunnel was just what those changes were or where they came from, other than the changes in forces at the tyre contacts. However,

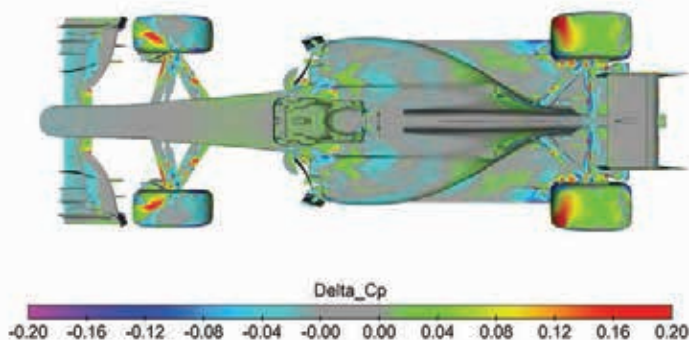

Figure 13: The tyres see different air too. Surface pressures from above show the extra drag from the rear tyres when the front flap angle was reduced

Table 6 – Downforce distribution at three flap angles, as a percentage of the total. Negative values represent positive lift contributions. The 2009 Sauber values are for comparison

Configuration	Downforce distribution			
	Baseline	-50 front flap	-100 front flap	2009 Sauber
15f 72r	Baseline	-50 front flap	-100 front flap	2009 Sauber
Front wing assembly	34.0%	32.2%	29.9%	29.0%
Front wheels, brake ducts, suspension,	-2.3%	-1.9%	-1.8%	-1.0%
Chassis, bodywork	-8.8%	-9.3%	-10.1%	-8.0%
Floor and diffuser	51.9%	52.9%	56.5%	52.0%
Rear wheels, brake ducts, suspension	1.1%	1.7%	0.9%	3.0%
Rear wing assembly	24.0%	24.4%	24.6%	25.0%
CL	-3.940	-3.945	-3.892	n/a

Table 7 – Drag distributions at three flap angles, as a percentage of the total. The 2009 Sauber values are for comparison

Configuration	Drag distribution			
	Baseline	-50 front flap	-100 front flap	2009 Sauber
15f 72r	Baseline	-50 front flap	-100 front flap	2009 Sauber
Front wing assembly	23.7%	21.9%	19.0%	20.0%
Front wheels, suspension, brake ducts	6.2%	6.8%	8.1%	10.0%
Chassis, bodywork	12.2%	13.2%	13.0%	10.0%
Floor and diffuser	6.0%	5.4%	6.3%	13.0%
Rear wheels, suspension, brake ducts	22.2%	22.2%	23.3%	17.0%
Rear wing assembly	29.7%	30.4%	30.3%	30.0%
CD	1.171	1.166	1.173	n/a

with CFD we can visualise pressure changes around the car, and the exercise here is very revealing.

MA: 'To get the balance close to 45 per cent front I tried two 5-degree increments (Figure 9) which gave around 44.7 and 47 per cent front.'

The results at two different ride heights are shown in Table 5. For comparison, according to the data in the Force India vs Lotus court case, the Lotus R30's 2010 launch target had L/D at 3.26 and balance at 42 per cent.

MA: 'Looking at the numbers in Table 5 and correlating the changes with Figures 10 to 13, although 5-degree and 10-degree flap angle reductions may not seem much, they

do allow more air to reach the rear of the car, and the global changes are interesting as well as how the balance change occurs. In the wind tunnel one would think that the balance just shifts to the rear because the front wing is working less hard, but there is more to it than that. Looking at the delta_Cp images makes things clearer. The rear wing is working better as a result of the 5-degree front flap angle change since more air is reaching the rear (Figure 10). This carries on further at the 10-degree flap angle change.

'Another thing that is apparent,' MA continues, 'from the images and results, is that the 5-degree changes are slightly different to the 10-degree

It was clear that other things changed as front wing flap was adjusted

Table 8 – Coefficients with the under-chassis vanes removed, compared to the balanced set up from earlier

Configuration	Front flap	CD	CL	L/D	%front
15f 72r	-10deg	1.173	-3.892	-3.320	44.63%
Above minus vanes	-10deg	1.169	-3.636	-3.110	49.26%

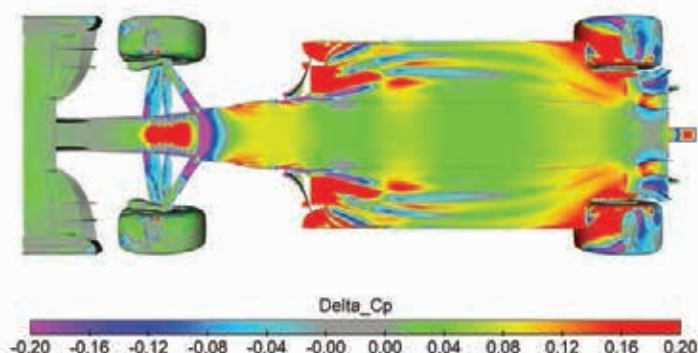

Figure 14: Removing the vanes from beneath the forward chassis had a pronounced effect on underbody pressures

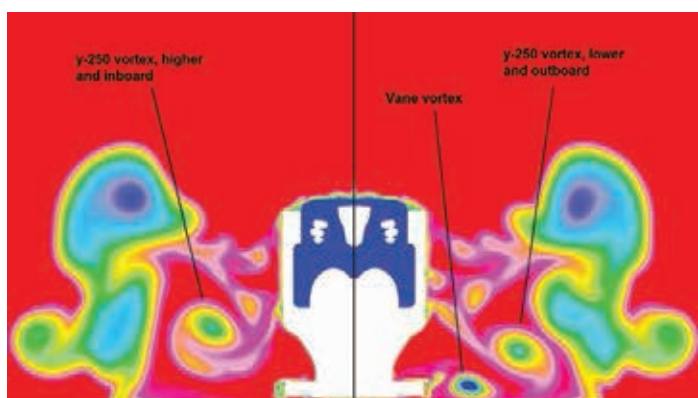

Figure 15: This transverse total pressure slice from just aft of the under-chassis vane location shows just how flow features were altered by the vane (right)

changes. The complex flow changes downstream of the car affect the diffuser and rear floor area negatively at 5 and positively at 10 (Figures 11 and 12) Also, the tyres see different air too (Figure 13), increasing front and rear tyre drag and, as a result, hitting our efficiency target! Perhaps the front wing could see more development at a later stage to reduce this effect and gain back what was lost with flap angle changes. One could perhaps use a smaller chord wing and run it closer to the ground to get similar performance to the current wing but which allows more air to the rear of the car. These are all thoughts which can be looked into later on as to how all the interactions around the car help optimise it further.

Table 6 shows the distribution of downforce contributions from the various component segments, this time at the three different flap angles, and the above trends can be picked out in the data. The front wing's contribution obviously reduces with decreasing front flap angle, the floor

and diffuser contribution increases, especially at the shallowest flap angle, and the rear wing's contribution increases slightly with each front flap angle reduction. Interestingly, chassis and bodywork positive lift increases with each flap angle reduction, a downside of more mass flow over the upper surfaces.

Notice that although the change in force distribution and balance are quite marked, the change in overall downforce across this adjustment range is quite small. The trends at the lower ride height were similar.

Table 7 shows the distribution of drag contributions in the same way, and again the patterns seen in the images are reflected in the

Interactions are a crucial aspect of the aerodynamics on any racecar, and this is particularly so on Formula 1 cars

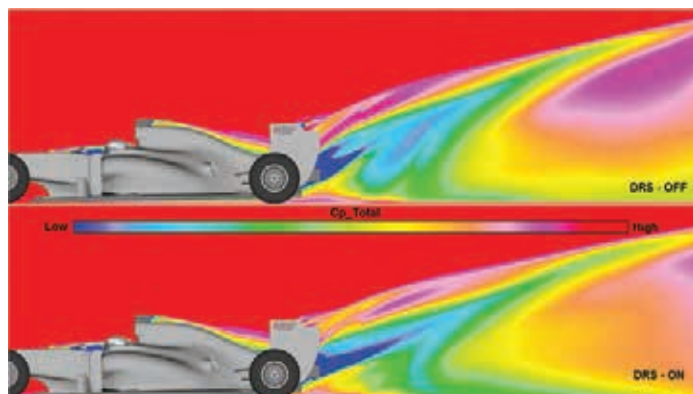

Figure 16: This longitudinal total pressure slice on the car's centreline compares upwash in the wake with the DRS opened (ON, bottom) and DRS closed (OFF, top)

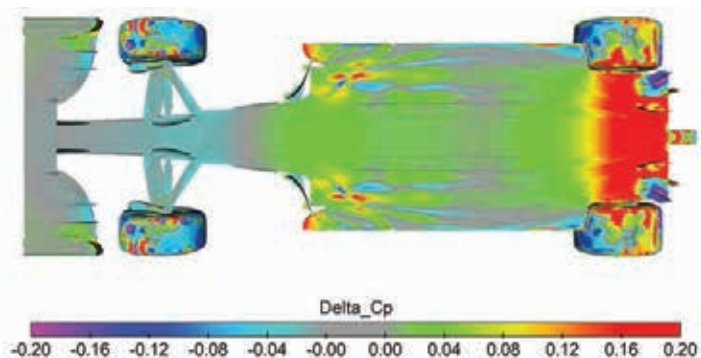

Figure 17: Activating the DRS also had a significant effect on underbody pressures

data. Here the overall trend is that total drag barely changes as the front flap angle is reduced, even though the front wing's contribution does reduce with each flap angle reduction. This is not really surprising because, simplistically speaking, the front flap angle reduction is allowing more air to encounter drag-inducing components downstream.

Under-nose vanes

Interactions are a crucial aspect of the aerodynamics on any racecar, and particularly on F1 cars, and in our introductory feature to this project in the July 2015 issue we briefly examined the role of the vanes under the forward chassis, located between the inboard front suspension pick up points. These vanes clearly generated a region of reduced pressure between them, under the chassis, and could also be seen to generate vortices which modified the downstream path of

the front wing's 'y-250' vortex and induced some downwash ahead of the main underbody. This was expected to increase the underbody's downforce contribution.

MA: This is an opportunity to demonstrate the importance of using vortices to manage the flow. To illustrate how important that component is on this car, I ran a simulation without the vanes on our now balanced car and compared it with the one with the vanes in place. It showed, as expected, a significant loss of downforce when the vanes were removed, around seven per cent (Table 8), and the delta_Cp image of the floor (Figure 14) shows the generally increased pressures on the floor's underside with the vanes removed. The vanes also affected the other components of the car too, as the total pressure slice taken just aft of the vane location in Figure 15 shows. The y-250 vortex followed a different path, changing the flow to the rear of the car, affecting the rear tyre region and other areas as well as the floor.

As Table 8 shows, the under-chassis vanes were responsible for 256 counts of extra downforce for just four counts of extra drag, and the balance shift was very marked too, a clear demonstration of how



BRITAIN'S FIRST ONLINE MOTORSPORT ENGINEERING DEGREE



Mosler GT. Winner
GT Cup, GTO Class
Championship

Learn Online and On-track with one of our Race Teams

College/School leavers – earn while you learn & gain practical motorsport experience

Mature Students – A second chance for a Motorsport Career, study flexibly alongside work & family

Foundation Degree (FdSc) Motorsport Engineering

BSc (Hons) Motorsport Engineering



Awarded by Staffordshire University.

The National Motorsport Academy, in partnership with Staffordshire University, is pleased to launch Britain's first online Motorsport Engineering degrees. In this competitive, global industry, Motorsport Engineers must have the broad range of skills demanded by the top teams. Working closely with the industry, we have designed our courses specifically to meet their requirements. Not only will our graduates be qualified Motorsport Engineers with practical experience, they will also be innovative, resourceful and commercially-focused. Making them highly sought after graduates.

Why study with us?

- Low Tuition Fees £5,500 per year/level
- Entry from 100 points
- Mature students welcome
- EARN while you LEARN
- Choose your own start date
- Your own personal tutor
- Unlimited tutor support, 5 days a week
- Stimulating, interactive, course content
- Online forum to meet other students
- Student loans available
- Free Autocad & industry software, NUS card
- Guaranteed work experience placement

How to apply

Please register on our website today at
<http://motorsport.nda.ac.uk/how-to-apply>

What you will study

- Mathematics for Motorsport
- Race Car Design & Preparation
- R & D Simulation and Analysis
- Fundamentals of Motorsport Technology
- Fluid Mechanics & Thermodynamics
- Engine Design, Development & Simulation
- Vehicle Dynamics, Physics & Data Acquisition
- Work Experience & Research Study
- Advanced Engine Development
- Aerodynamics
- Hybrid & Electric Vehicle
- Final Project



New for 2015 Lotus GTE (Le Mans). Over 30 races planned.

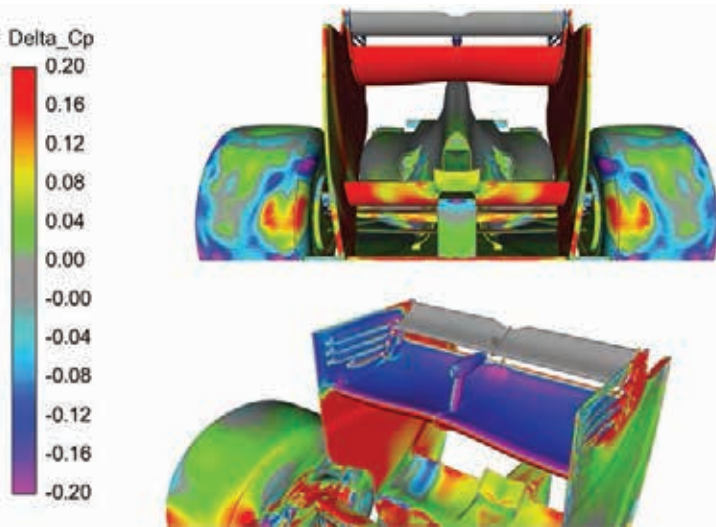

Figure 18: The opening of the DRS had the expected effects on the rear wing itself

a seemingly modest component, designed and located correctly, can make a really significant difference.

DRS code

In 2009 the rules for rear wings in F1 changed so that they became much narrower (750mm instead of 1000mm) but with the same maximum chord, and were mounted significantly higher (maximum height became 950mm from the reference plane instead of 800mm). They were, therefore, located in slightly 'cleaner' air, but the loss of 25 per cent in plan area meant they were considerably less potent than previously. This was all part of a broad raft of changes made to enable the cars to run close together more easily, the aerodynamic changes focussed on reducing total downforce and cleaning up the cars' wakes. However, two years later the 'Drag Reduction System' or DRS became

an integral part of the rear wing in order to further increase overtaking opportunities. DRS together with the 2009 dimensions and location of the rear wing were still in use in 2013, and indeed are currently.

MA: 'The rear wing on the pre-2009 cars had a strong interaction with the diffuser which in turn drove the underbody, working as a system. In 2009 wing height was increased to reduce that interaction. However, the interaction still exists and we can see that by looking at the DRS system. The wing produces a strong upwash that interacts with the diffuser and lower beam wing on our 2013 model, whereas a DRS activated wing changes things significantly.'

'The DRS system is there to reduce drag on the straights. Simple explanations say that the flap opens up and the stagnation region (and associated high pressure) on the flap's forward facing surface reduces, and

Table 9 – Coefficients and balance with and without DRS

Configuration	Front flap	CD	CL	L/D	%front
15f 72r	-10deg	1.173	-3.892	-3.320	44.63%
Above with DRS deployed	-10deg	1.083	-3.610	-3.330	48.86%

Table 10 – Drag force distributions with and without DRS deployed

15f 72r, -100 front flap	Drag distribution with DRS closed (OFF)	Drag distribution with DRS open (ON)
Front wing assembly	19.0%	20.6%
Front wheels, suspension, brake ducts	8.1%	10.2%
Chassis, bodywork	13.0%	13.2%
Floor and Diffuser	6.3%	5.8%
Rear wheels, suspension and brake ducts	23.3%	26.2%
Rear wing assembly	30.3%	24.0%
CD	1.173	1.083

the suction on the other side of the flap diminishes, too, jointly reducing drag as a result. However, there is more to it than that. Once the DRS is activated, the strong up-wash component reduces, which can be seen in Figure 16, where slices of total pressure at the longitudinal centreline of the two set-ups are compared, one with DRS open (ON) and one closed (OFF). The resulting changes are apparent in the delta_Cp plot Figure 17 where the under floor and diffuser region have clearly lost downforce.'

Figure 18 is a delta_Cp plot showing two views of the rear of the car, comparing with and without the DRS activated. It is evident that not only has the high pressure on the wing's upper surface reduced and the low pressure on the lower surface of the wing increased (both leading to less downforce from the wing), but the pressure on the underside of the lower beam wing has increased, also contributing to the reduction in downforce. So the downforce contributions of the wing, the lower beam wing and the diffuser and main floor all reduce when DRS is deployed, and this results in a fairly significant shift in balance too, as Table 9 summarises.

The change in drag is, as stated earlier, what DRS is all about, and Table 9 shows that drag reduced

by 7.7 per cent with DRS open. By looking at the force distributions we can see that the dominant source of drag reduction is indeed the rear wing, as shown by Table 10. The proportions in the 'DRS open (ON)' column are obviously relative to a lower total drag value, which is why some of the smaller percentage changes arise, such as the barely changed actual drag contribution of the front wing, although other smaller changes are due to actual changes in forces. But it is evident that the biggest change was to the rear wing's drag contribution.

So in that respect this simulation bears out that the DRS fulfils its primary purpose; however, what we saw in the preceding paragraphs is that it also makes significant changes to downforce and its distribution.

Summary

We have seen how changing large components (wheelbase) and small details (e.g. diffuser slots or small front flap adjustments) can each have 'global' and sometimes surprising effects on aerodynamic coefficients and balance. In the next instalment we will examine how a switch to ground effect might change Formula 1. Thanks to Dynamic Flow Solutions for its help with this piece.



Dynamic Flow Solutions

Dynamic Flow Solutions Ltd is an aerodynamics consultancy headed up by director Miqdad Ali, ex-MIRA aerodynamicist, who has performed design, development, simulation and test work at the highest levels of professional motorsport, from junior formula cars to World and British touring cars, Le Mans prototypes, up through to F1 and Land Speed Records.

Contact:

miqdad.ali@dynamic-flow.co.uk

web:

www.dynamic-flow.co.uk



Ex-MIRA aero man Miqdad Ali is the boss of Dynamic Flow Solutions Ltd



'The rear wing on the pre-2009 Formula 1 cars had a strong interaction with the diffuser, which in turn drove the underbody'

What's the
secret
about the new 911 GT3 Cup's
new brakes?



It's Quicker.



OFFICIAL PARTNER

PORSCHE
MOTORSPORT

PFC
BREMSE

Back lash

Could the seating positions in some competition cars be responsible for a spate of recent spine injuries?

By PETER WRIGHT

Anthony Davidson prepares to enter an MRI scanner. He is in his race seat, which is fixed into the position it was in when he was injured in a crash at Le Mans in a Toyota LMP1 back in 2012





It is a fact of life in the world of safety, especially as applied to automobiles, both road and track, that as one problem is solved, others appear that may have been hidden by the fatal nature of the original problem. A case in point is air bags and seat belts. Once these became widely used, fatalities in frontal impacts reduced significantly, but lower limb injuries caused by structural intrusion into the footwell, appeared to increase. They were always there in severe and fatal accidents, but were masked by the other devastating injuries. Yet the long-term disabilities caused by lower leg injuries can have a social and health cost that is of the same order as a fatality, and so the next task for the safety engineer is to solve these new, exposed problems.

Spine injuries

In motorsport, Frontal Head Restraints (e.g. HANS), headrests, and racing nets have almost banished serious and fatal injuries due to basilar skull fractures and cervical fractures, in impacts from all angles. Massively strong CFRP monocoques, optimised tubular frames, and roll cage reinforced production car shells have helped to prevent intrusion injuries in all but the most severe impacts. But with survival rates significantly higher than in the past and particularly pre-1994, one injury type that is starting to emerge in a variety of forms is spinal injury. Depending on the nature of the impact causing the injury and the severity and location of the injury itself, this can be anything from back pain to quadriplegia, and can be fatal if the paralysis affects breathing.

Spinal injuries have occurred in all types of competition cars: single-seaters, LMP two-seaters, GT, touring cars, rally and off-road cars. In circuit racing they tend to be a consequence of impact into barriers or other cars; in rally and off-road they also include injuries due to heavy landings following a jump. Recently there has been a focus on LMP cars following Kazuki Nakajima's accident at Spa in the Toyota, when he hit the back of an Audi driven by Oliver Jarvis. This follows on from Anthony Davidson's accident at Le Mans in 2012, also in a Toyota, and Guillaume Moreau's LMP2 accident in Le Mans testing the same year.

FIA action

Following Davidson's accident, the FIA Institute entered into collaboration with the Toyota Motor Company, Japan, to research the causes and potential solutions to his injuries, using their FEA model of the human body: THUMS (Total Human Model for Safety). THUMS has been developed over 20 years and is acknowledged as being the industry standard, widely used by automobile manufacturers and academic research laboratories. An initial report on the programme has appeared in the FIA magazine *Auto*, issue 07 (www.fia.com).

Because this programme is ongoing and is necessarily subject to confidentiality due to the involvement of personal medical data, I am not going to describe this work in detail. Instead I am going to attempt to outline the fundamental problem that leads to these injuries, and identify the implications for racing car design. I am not a doctor and sometimes have problems with fully understanding the excellent

team of medics who work with the FIA, due to the fact that they so often speak in Latin! Many years ago, my Latin teacher wrote on a piece of work I handed in: 'Where have you spent your life so far? In an incubator?' I gave up Latin at the first opportunity.

Fortunately however, the problem is primarily an engineering one, or more specifically, biomechanical, and so I will try and make it understandable to non-medical readers of *Racecar Engineering*. The potential solutions involve the laws of physics (forces, accelerations, stresses, moments, and so on), which engineers readily understand.

The spinal column is a stack of segments of bone (vertebrae) interleaved with soft fibro-cartilage (intervertebral discs) and held together with ligaments. It has evolved into the current curved shape since our species rose up onto two legs and stopped hanging about in trees. It is able to sustain limited compressive

Fortunately this problem is primarily an engineering one

loads provided it is in its correct shape. Bend it and try and pick up a heavy weight, and some part, most probably a disc, is likely to fail. Hence the advice: 'Keep a straight back, and bend knees to pick up something heavy.' If the spine does not carry the load centrally, the muscles and ligaments will compensate and they will also become strained, whilst simultaneously increasing the net load on each vertebral body.

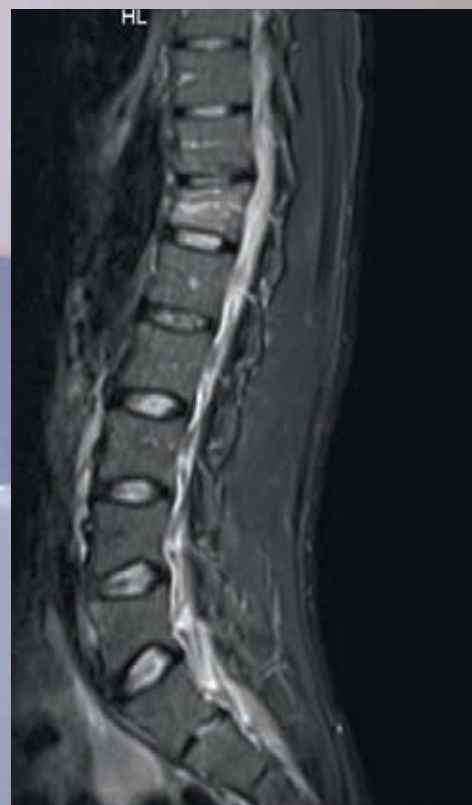

Anthony Davidson's X-ray after his 2012 crash at Le Mans showing how close a fractured vertebra came to his spinal chord. Davidson climbed from his car unaided. When Nakajima had his accident he was instructed to stay put.



Modern racecars are built with safety in mind as much as performance, but is there a hidden danger lurking in the cockpit?

Table: 1. Strength of vertebrae (T8-L5), and g-loads sustainable for a 75kg human

Vertebra	Max failure (N)	Min failure (N)	% body mass	Max g	Min g
T8	6400	5400	33	24.9	20.8
T9	7200	6100	37	25.0	21.0
T10	8000	6600	40	25.7	21.0
T11	8600	7200	44	25.1	20.8
T12	9000	6900	47	24.5	18.6
L1	9000	7200	50	23.0	18.2
L2	9900	8000	53	23.9	19.1
L3	11000	9000	56	25.2	20.4
L4	12000	9000	58	24.3	19.7
L5	12100	10000	60	25.7	21.2

Figure 1: Average failure stress of 223 vertebrae, L1-L5.

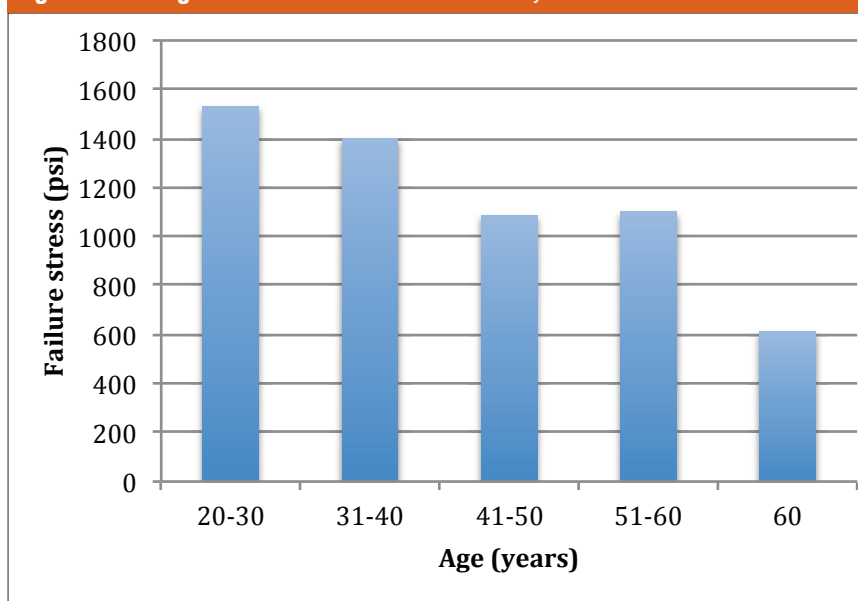

The seating positions in most competition cars are quite inappropriate

The problem stems from the engineering of the spinal column. Like a masonry column, made up of blocks or bricks, it will take high compressive load but only low tension loads. Hence if it is bent, part is subjected to tension which it cannot sustain; not only is bending strength compromised, but any compressive loads are concentrated and the local peak stresses may cause the masonry to fail in compression.

In accidents the spinal column may be subjected to loads, in compression or tension, and bending moments, or a combination of the two. Only if it is in the most tolerant posture is it best able to sustain these loads without injury.

Spinal gap

There are three compression load paths in the spine. The load distribution in each will depend on the nature of the loading (pure compression and/or bending) and on the curvature of the spine. The Facet Joints are bony parts of each vertebra that engage through low friction pads with the adjoining vertebra. They are strong in compression, but can sustain no tension loads other than via the connecting tissues and muscles, and a gap will develop between them as the spine is bent forward. At this point, the entire compression load is carried by the middle and anterior columns, and the disc that separates the vertebrae. The more the bending of the spine, then the greater the load on the anterior column.

If the compressive loads, or more specifically, the local compressive stresses exceed the strength of the bone material, failure will occur. This type of bone failure, and disc damage, are not in themselves life-threatening, but through the middle of each vertebra passes the spinal-cord, the bundle of nerves that pass vitally important messages to and from the brain to other parts of the body. If a bone fragment is displaced and impinges and damages the spinal cord, paralysis of muscle functions served below that point is very likely.

The problem that most often occurs in a motorsport accident is when the spine of the seated driver (and/or the co-driver in rallying and off-road events) is subjected to an impact load through the seat pan, in a rearward and/or upward direction, and the strength of one or more vertebrae is exceeded. There is a separate class of impact, notably rear impacts, that can also injure the spine, but they are more complex and so I will deal with them separately.

Ejection seat research

There was intensive research into spinal injuries due to seat pan accelerations during the development of the aircraft ejection seat. Study of this work provides a very comprehensive background for what we need to know: the injury mechanisms; critical factors; and how to maximise avoidance of injury. Interestingly, it appears that racing car designers have not

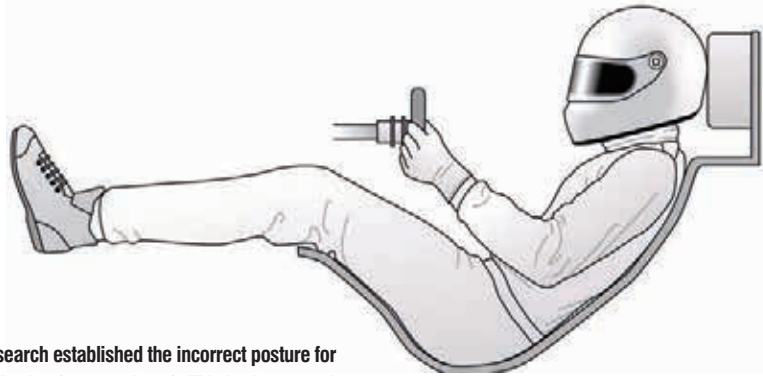

Early ejection seat research established the incorrect posture for a pilot when he was ejecting from an aircraft. This is shown on the left, and is remarkably similar to that of a modern racing driver, as the diagram on the right (courtesy of John Rigby) clearly illustrates

Fig 2: Seat inclination history

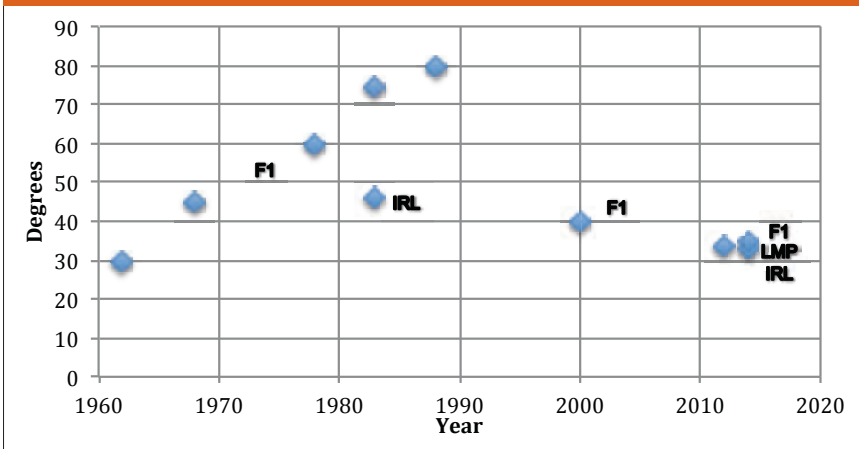

studied this work, as the seating positions in most competition cars, especially circuit cars, are quite inappropriate for minimising the potential for injury.

Ejection seat design and development started in the early 1940s, in Germany. By the mid '40s the systems had been developed to such an extent that it was possible to eject the pilot without injuring him. Post-war the UK ejection seat company Martin Baker Ltd initiated a comprehensive programme of engineering development and human response testing.

In the late '40s, the USA also undertook a major R&D effort to determine how to safely eject a pilot clear from a jet aircraft. A definitive paper on the subject was written in 1967 by US Air Force Captain John H Henzel, entitled: *The Human Spinal Column and Upward Ejection Acceleration: An Appraisal of Biodynamic Implications*. In this he states: 'Design and material properties of the normal vertebral column are sufficiently constant that when structural characteristics are defined and acceleration profiles known, prediction of failure may be made. That very much sounds like an engineering statement to me. The paper identifies three critical issues: 1: The biomechanical characteristics of the vertebrae making up the spinal column. 2: The magnitude and characteristics of the acceleration pulse. 3: The posture of the seat occupant.

The first of these looks at the maximum acceleration the spine will withstand under ideal conditions. The second considers the effect of the rate of onset of that acceleration on the maximum value, while the third investigates how the shape of the spine reduces the peak acceleration that it is able to withstand without injury.

The paper analyses data on vertebral strengths from a number of sources and arrives at probability of failure for a given acceleration load (g) along the spinal column. This is based on the maximum and minimum compression failure load of the vertebra tested, and the body mass supported by that vertebra. The figures for T8 to L5 (the 8th Thoracic vertebra to the 5th Lumbar vertebra) are shown in Table 1. This indicates that there is a minimum strength around T12 to L1, which statistically is where the majority of ejection seat injuries occurred. This is also generally true for motorsport spinal injuries in frontal and vertical impacts.

More worrying (particularly for those of us who are over 60 years) is the data that indicates that there is a significant fall off of vertebral strength with age (Figure 1). The most severe reduction occurs over the age of 60.

It was this data that led the developers of early ejection seats to limit the acceleration to 18g (thus limiting the compressive load in the critical T12 to L1 vertebrae to under

7000 N). However, early tests still resulted in spinal injuries below 15g, as the catapult used generated an extremely rapid initial acceleration rate of over 1000g/second. Once it was realised that spinal injuries were not only a function of peak acceleration, but also the rate of onset of acceleration, it was established that 18-20g could be tolerated provided the rate of onset of acceleration did not exceed 250-300g/second. With cartridges, and later rockets, to accelerate the seats, the acceleration profile could be accurately tuned to minimise the potential for injury.

Straight talking

Earlier ejection seats were fired by the pilot reaching down between his thighs and pulling up a firing handle. However, this put his spine into a forward curved posture, the worst for sustaining vertical compressive loads.

It soon became clear that restraining the pilot into the ideal, straight-backed posture prior to ejection made his spine much more tolerant to acceleration loads. Pulling a face blind down to initiate an ejection sequence not only ensured correct posture, but also protected the pilot from windblast at high speeds. Once fast jet pilots adopted helmets and visors, this latter advantage was no longer relevant, and initiation was returned to a seat pan mounted handle. However, a powered shoulder harness retraction system was fitted, fired early in the injection sequence in order to pull the occupant's shoulders back into the correct posture for ejection. Development of the firing gun and rockets permitted significantly 'softer' acceleration, but sustained sufficient thrust to ensure a high ejection velocity to separate the seat from the aircraft.

One injury type that is starting to emerge in a variety of forms is spinal injury



Boffins have been looking into the science of ejection seats since the Second World War and by studying its development we might be able to limit spinal injuries in motorsport

Armed with this 50+ year old information on the essential parameters for subjecting a seated human to acceleration along the axis of the spine, we can now apply the three basic principles to the driver of a modern racing car. A survey of seat inclination in circuit racing (F1, IRL, and LMP) is shown in Figure 2. This starts with the Lotus T25 in 1962, where Colin Chapman laid Jim Clark down at 30-degree to the horizontal. He was able to do this due to the relatively short, small capacity V8 engine, and by packaging the fuel in pannier tanks. Over the subsequent years, following the much safer Lotus T79 arrangement of a single, central fuel tank between the engine and the driver, and regulation changes to ensure that the driver's feet were behind the front axle centreline, seat angles had to become steeper, culminating in the 75-80-degree angles of the fuel-thirsty turbo cars of the late 1980s.

Refuelling, as used in CART and IRL, F1 from 1982-2009, and LMP permitted a smaller tank. This, combined with a trend away from long V12 and V10 engines towards shorter V8s and V6s has allowed the driver to be reclined back down to around 35-degrees. This is now the norm. The problem is that, if the driver is reclined to 35 degrees whilst retaining the ideal posture as defined by aircraft ejection principles, he will be looking at the sky. Drivers

are encouraged to look forward, just over their steering wheel and to do so brings the head and shoulders forward and curves the spine. Raising the legs to allow a high nose also rotates the pelvis, inducing curvature into the lower spine. Foamed-in-place seat construction techniques ensure this posture is locked in. This is the worst possible configuration of the spine to sustain acceleration along its axis.

The crash pulse causing injury in the majority of cases of frontal/vertical impacts is generated either by a vertical input during a frontal crash (e.g. Nakajima's Toyota running into the back of the Audi) or by a heavy landing (e.g. Davidson at Le Mans, or World Rally Championship and Desert Raid cars). This landing nearly always occurs while the car has forward velocity and so generates a longitudinal deceleration due to friction as the underside of the car hits the road.

Taking hits

Consider a simple acceleration pulse where during 5g braking the car hits the kerb with the underfloor plank. It generates 10g vertically and 10g longitudinally to give a total of 15g longitudinal acceleration (this assumes that the braking is unaffected). The resultant acceleration is an 18g vector, at 34 degrees to the horizontal – aligned almost exactly with the seat back and the curved axis of the driver's spine. An acceleration rise rate of over 1000g/second in this sort of impact with a very stiff plank is not unusual. Pure longitudinal and lateral impacts involve much softer structures – e.g. barriers, and front, rear and side impact structures – and so acceleration rise rates are much lower.

Because of the acceleration rise rate of vertical impacts, and the curved spine, one would expect injuries to one or more vertebrae, in spite of the peak g being within ejection seat determined limits. This impact scenario is not that excessive in racing. If the car takes off and lands heavily, as often happens when one car runs into the open rear wheel of another, or the car takes off aerodynamically as happened in Davidson's case, or in rallying and off-road racing where the road profile causes the car to take off, the vertical acceleration pulse can be much greater.

Rally and off-road cars tend to benefit from a fairly upright seating position, but the co-driver is often crouched forward over his notes, with his spine bent. It is significant that it is more often the co-driver who suffers in this sort of impact.

The above shows just how likely a driver in a modern racing car with a reclined seat is to suffer a spinal injury if there is a vertical component to the impact pulse. The issue is compounded if the longitudinal component is of sufficient magnitude and duration to cause the driver's shoulders to move forward against the restraint harness while his pelvis is restrained by the crotch straps and the seat pan kick-up. Seat pan kick-ups have become quite pronounced since the pedals were raised to allow high noses. If there is a concurrent vertical impact a short time after the longitudinal component starts, his spine will have become even more bent, with most of the curvature likely to occur around the transition from the thoracic spine to the lumbar spine, below the ribcage: i.e. T12 to L1.

A female IRL driver was escaping injuries her male colleagues were suffering



Seat pan kick ups are a notable feature of modern raised-nose racecars, but they can bring a vertical pulse to the crash force, which could have serious consequences for the driver's spine

Rear impacts are somewhat more complex and do not require a vertical component to cause spinal injury. A longitudinal rearward acceleration – fairly common in wall impacts on the high-speed ovals – causes the whole body of the driver plus the mass of his legs to move rearwards. Because of the reclined seat, the torso will ramp up the seat, restrained only by the shoulder belts. This will load the curved spine causing lower back injuries. If the helmet is embedded in the headrest and thus locked to it, cervical spine (neck) injuries may also occur. Dr Terry Trammell has carried out valuable research into the effects of this type of accident for the IRL (*Spine Fractures In Drivers Of Open-Wheeled Open Cockpit Race Cars, Aspetar Sports Medical Journal –Terry Trammell and Kathy Flint*), and as a result a series of measures have been implemented in IndyCar, bringing about a significant reduction in injuries.

Pelvic thrust

One of the most fascinating and key findings was that a female IndyCar driver was escaping injury in rear impacts her male colleagues were suffering. Dr Trammell realised that: 'This can be accomplished by creating a pelvic 'bucket' that fits to the pelvis and adding a prominence that promotes normal lumbar lordosis. These factors combine to reduce the compressive loads on the thoracic and thoracolumbar vertebra and the fracture risk is mitigated. The pelvic bucket is most easily accomplished in a driver with a broader pelvis and gluteal contour (norm in female drivers). The seat material cladding should deform and allow the pelvis to 'sink in' to the seatback, like a baseball into a catcher's mitt, but not 'bottom out' when you catch a baseball and it stings your hand through the glove.'

For the last 50 years or so crash testing has used Anthropomorphic Test Devices (ATD), more commonly known as dummies, e.g. Hybrid III and THOR, and HyGe sleds to simulate the dynamics of humans and to measure critical biomechanical loads during impacts. Used by the automobile industry originally for restraint system and airbag development, some parts of the dummies do not simulate the represented parts of the human anatomy adequately for reclined seating positions and six point restraints. This has compromised research into spinal injuries, although Hybrid III has performed a sterling job in the development of head and neck restraint systems e.g. HANS, rally car seats, and racing nets. However, fortunately Toyota has invested over the past 20 years in the development of THUMS.

Rule of THUMS

THUMS is a 20-million element FEA model of the human body complete with skeleton and all internal organs and systems, whose biomechanical characteristics and injury criteria are known. Seat, restraint systems and protective equipment can be structurally included in the model and the whole subjected to a specified crash pulse.

Outputs include dynamic motion, loads and stresses, pressures etc., to enable the causation of injuries, and systems to mitigate them to be studied. Requiring significant computing power (10,000 CPUs, and 24 hours to complete just 150ms of a crash), THUMS is now the industry standard for mathematical models of humans in automotive crashes. The FIA Institute is working with Toyota to apply THUMS to racing car crashes and spinal injuries in particular.

It is too early to predict the outcome of this collaborative research and development,

or to predict regulations to alleviate the problem. However, areas that will be looked at closely include: determination of injury mechanisms; seat back inclination; restraint system characteristics and geometry; seat geometry; impact attenuating foam seat inserts; compliant/energy absorbing seat mountings; impact attenuating systems in the floor of the car; and harness pre-tensioning.

It is already clear from the above analysis that one of the most significant parameters to affect the likelihood of spinal injury, whether in a longitudinal/vertical or a rear impact, is the inclination of the seat back. Varying over the years from 30 degrees to 80 degrees, the pressure to lie the driver down comes from the aerodynamicist, although there is some influence from CG height.

Regulating this critical parameter, whether for single seaters or two seaters would be equal for all. However, such a drastic step would have a large effect on the configuration and look of racing cars, and so a sound scientific basis must be established before doing so.

If it just so happened that fans could see more of the driver and what he was doing while driving the car, so much the better!

Acknowledgements: This article was inspired by work carried out by Dr Michael Henderson and Dr Terry Trammell.



The developers of early ejection seats limited acceleration to 18g

Future series

Designing in parallel – rather than in series – is a new approach to grand prix and LMP1 car development

By SAM COLLINS



Nicolas Perrin has taken unusual steps in his career. He had worked with Courage Competition as a race engineer, and then joined the Williams F1 team as a race performance engineer. But he gave it all up to develop a new top-level competition car design methodology. He built a Le Mans prototype, the Pescarolo 03, around the tub of the Aston Martin AMR-One but that debut at Le Mans was beset by problems. He designed an LMP1 car and sought funding through a public campaign, and now has designed a Formula 1 car to 2016 rules.

'I always wanted to design a full car and I've always wanted to work differently from the others,' says Perrin of his career choices. 'When

I was race performance engineer for Nakajima at Williams, I stopped what I was doing and became a designer. Normally from that position in your career you work hard, get better and end up as the lead race engineer on the car. But I was so interested in the project overall that I switched streams. At the age of 30 it was a one-way thing. Luckily Williams gave me the support and helped me. When you are a race engineer your main tools are Excel, and other data management things, but you rarely use CAD. So I found myself learning how to do CAD with a bunch of guys almost 10 years younger than me fresh out of university!'

Perrin eventually parted company on amicable terms with Williams and started up on

his own, in a small office in the Yorkshire Dales. 'I started work in 2011, with the aim to deliver a car for Le Mans in 2014.'

He had decided not to work like a traditional design consultancy, instead he had a new approach which he believes is more efficient.

'I was inspired by Adrian Newey and the success he has had at Red Bull, it gave me the confidence to do this,' he says. 'It showed me that designing and delivering a good racing car is not just about having an army of people and a complicated structure. We are not doing mass production here, it's crafted high-end design so I think that it is important to have one person in charge of the whole thing. That person had the whole car in his head and everyone under him

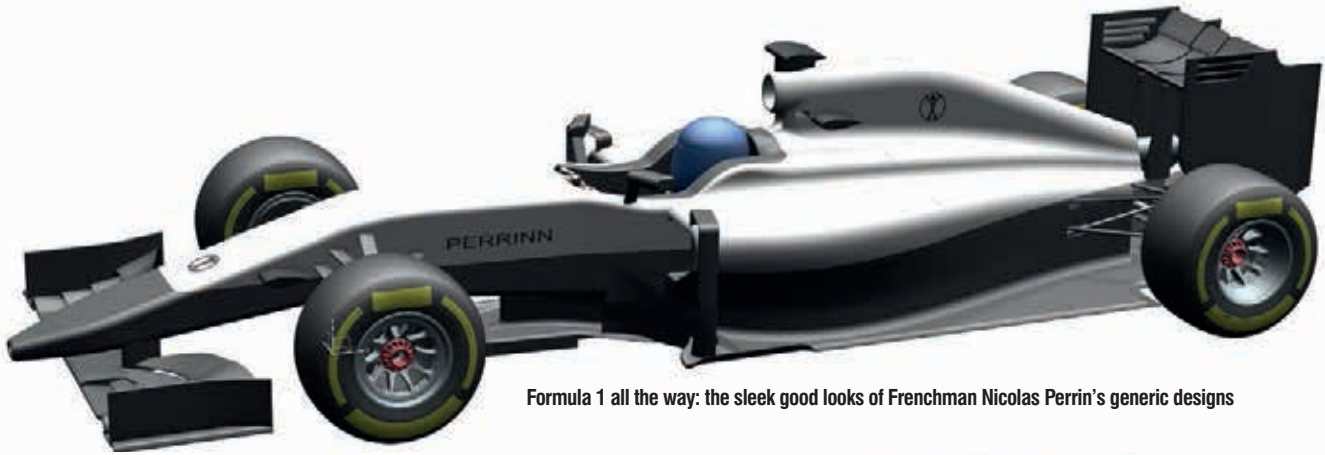

Formula 1 all the way: the sleek good looks of Frenchman Nicolas Perrin's generic designs

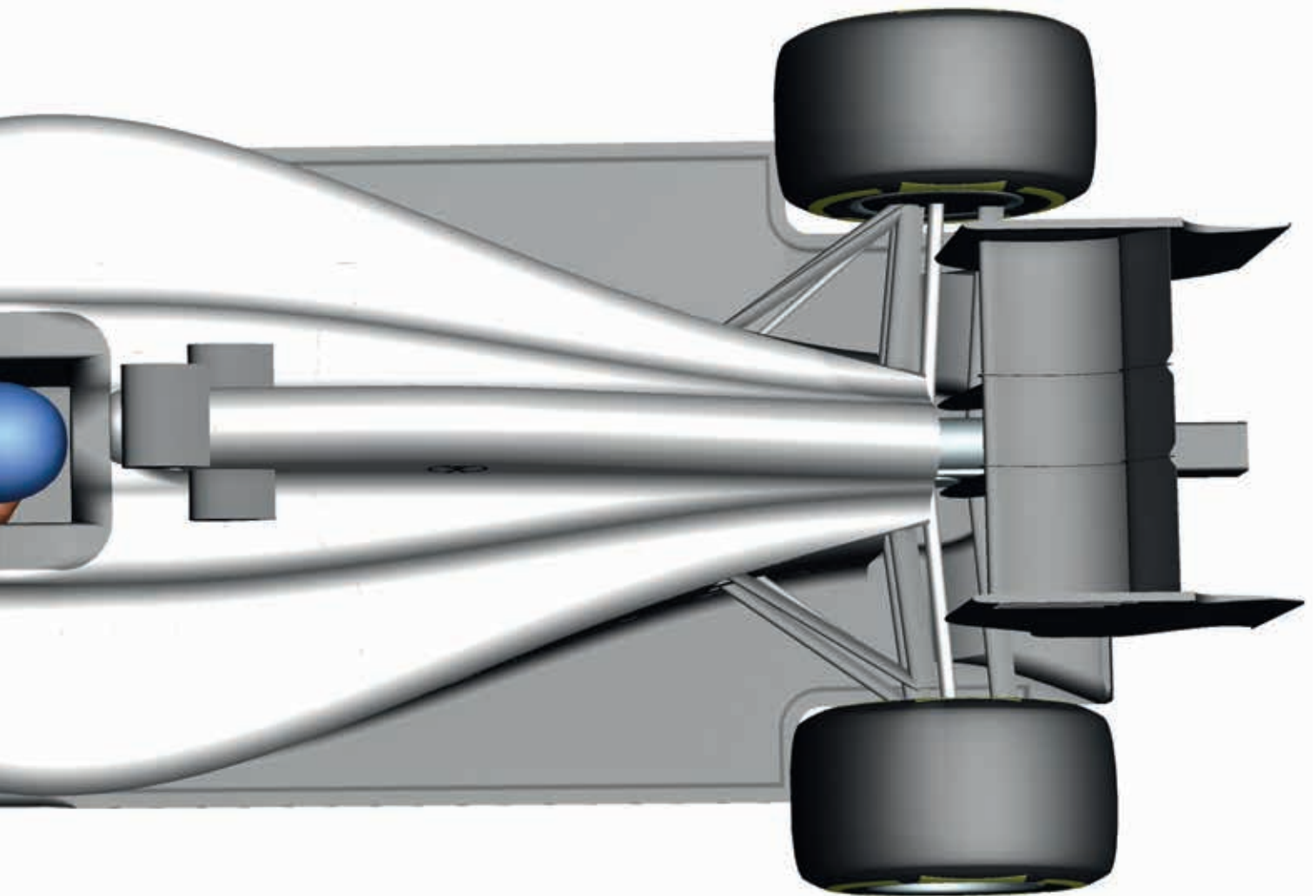

follows his lead, rather than giving too many people the opportunity to try out whatever pet project they have. That's how I did the LMP1 car.'

Perrin started work sitting in his office with the rulebook, working out what he could do with the design. 'I read in *Racecar Engineering* what Newey was doing. Back in 2009 there was the big rule change in Formula 1, so before that he just went away for two or three weeks on his own with the rulebook and started sketching things. I did that with the LMP1. You work out all the big things, nobody questions you.

'So before I brought in a team to do the detailed design I sorted all the main questions, the architecture of the car was complete. That saved so much money, there were no meetings

to discuss things, no committee meeting to decide the wheelbase for example. I decided all of this on my own. Of course you can revisit it later if something happens,' he explains. 'I was the first person to start proper work on a 2014 LMP1, starting three years in advance, 18 months ahead of Porsche. I started work before the rules were finalised and fed back a lot at the FIA meetings because I was the only one working on the new rules at that time.'

Into the detail

Once Perrin had worked out the major design elements he started work on the detailed subsystems. 'But then I brought in other designers to help on the details. On the uprights

for example I worked with a guy I knew from Courage. He designed the whole upright on his own. But I gave him the suspension points, all the kinematics, all the offsets, the brake disc, everything. Then we fully designed the components right down to the MMC material used and the machining. The FEM was all done, all of the normal things were done. But instead of doing it in parallel we did it in series.

So a normal constructor would need a stress department always working on optimising parts, an aero department getting the best flow structures and all of that. But I spent a year on my own just doing the aerodynamic work, then, with some other people, three months just doing the FEM.'



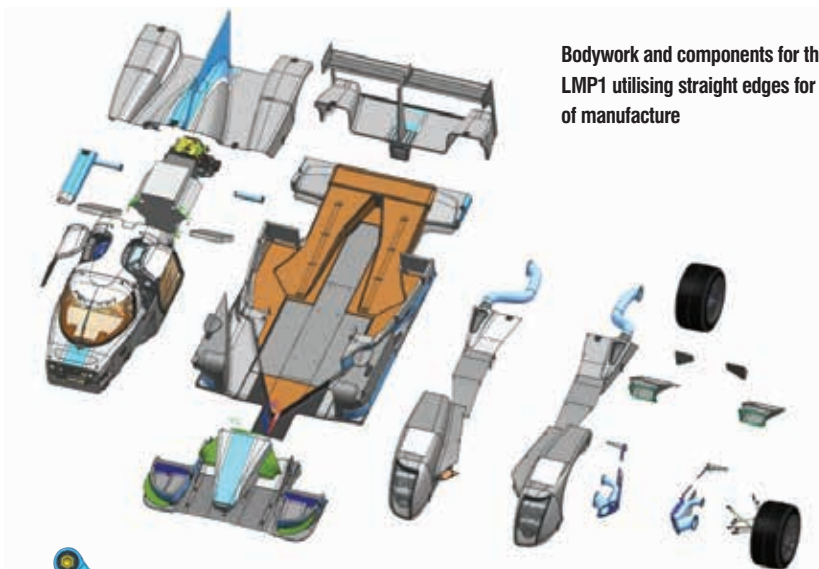

Bodywork and components for the LMP1 utilising straight edges for ease of manufacture

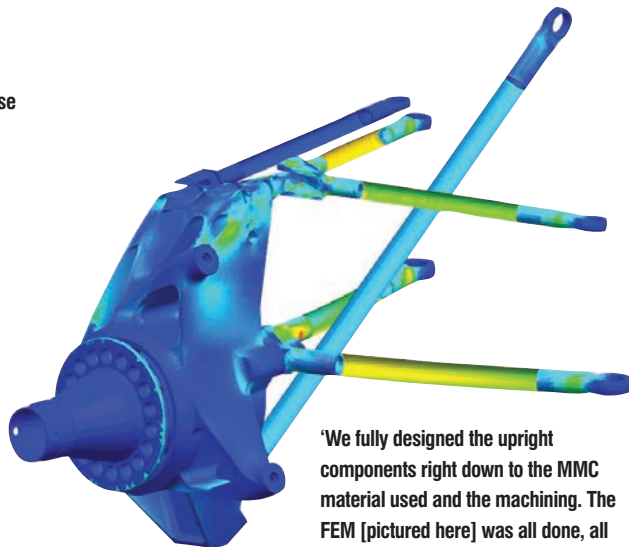

'We fully designed the upright components right down to the MMC material used and the machining. The FEM [pictured here] was all done, all of the normal things were done'

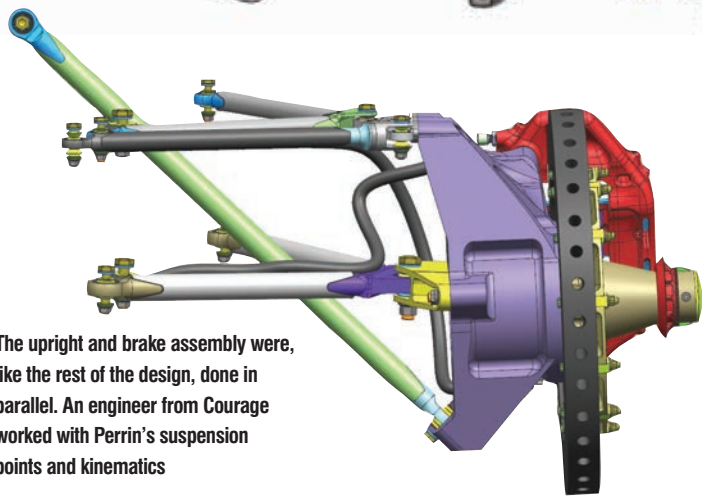

The upright and brake assembly were, like the rest of the design, done in parallel. An engineer from Courage worked with Perrin's suspension points and kinematics

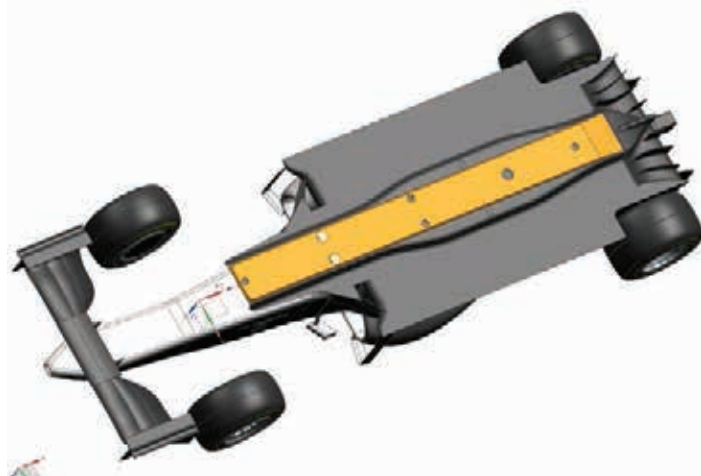

Once the design details were completed the extra designers, who had been working on a freelance basis were all released. It is a key part of Perrin's approach, working through the project in series, tackling each problem and subsystem in turn rather than developing different parts in parallel.

'I am not doing things for the sake of being cheap, it's just my way of doing things. Rather than managing a group of designers I tend to design a lot myself. I put a line through the car from front to rear, it is all my work,' he explains. 'I don't split things out into modules, and give them to different teams, so it's a very different way of working to normal.'

'The model is very cost effective. We do not have an infrastructure that we have built up, we do not have to pay 200 people every month even if there is no work to do. We have done it differently. Rather than rushing the design and spending money to do things in a short amount of time we have taken longer. If you allow lots of people in a committee to get involved you

end up just driving costs up to a level that is unsustainable so this is a low cost way of working, but it's also a way of delivering a very low cost car. Its important to stress that we want to deliver a high quality car still.'

Designing in series

Perrin believes that his approach of designing the car in series also allows for a number of very pragmatic approaches to the car. 'Normally in Formula 1 an aerodynamicist will come up with a new wing design, the part is scaled then tested in the wind tunnel. If it is good then it is signed off, but then it ends up being redesigned for CAD quality purposes, most teams have people just re-doing surfaces, that then goes to the composites and manufacturing department who take the shape and turn it into an assembly, with a structure inside, they will work out the thickness of the composite lay up and all of that,' the Frenchman explains.

'But what I do is different. Before I get into all of the CFD work and things like that I do the

composites first. I have learned that if you do not push yourself to design the final component including the thickness it will have, you end up thinking of shapes and solutions that are not really possible in terms of manufacturing. But if you work only on the final components you save time and money because you know that it can be made.'

During the development of the Perrinn LMP design (the company name spelled with a double 'n') its creator was sidetracked by a separate car design project, the Pescarolo 03. History shows that the Aston Martin AMR-One based, Judd-based design was not a success but Perrin learned some important lessons.

'On that car I did not use the method of thinking about the final part. I did a pure conceptual aerodynamic package, and when we got the go ahead, we then had to make it around existing designs and had to work in a real rush,' he admits. 'When my aerodynamic surfaces were turned into real components they did not fit on the car easily. As a result, in some areas that are quite sensitive and critical, especially under the chassis, were not sealing properly, and that cost performance because the parts were too complex to make. Now, I want to be sure that you can make a real car with the parts. If I knew then what I know now I would have done the concept design differently.'

“We do not have an infrastructure, we do not have to pay 200 people...but I'm not doing it for the sake of being cheap, it's just my way”

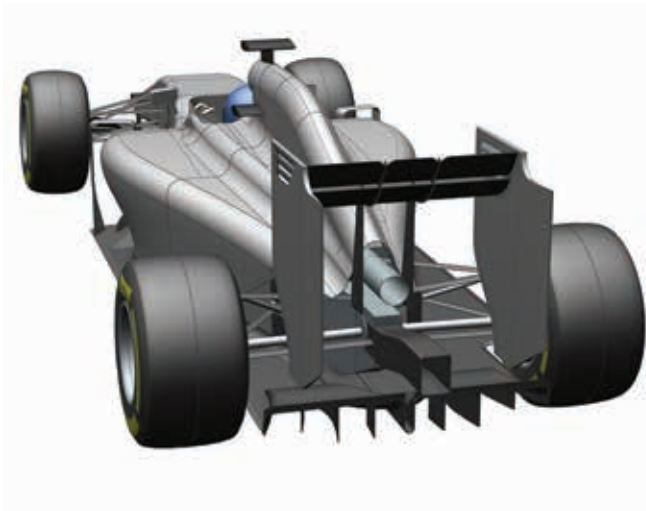

'With this car a driver could be fully ready for F1,' claims Nicolas Perrin. 'It is a way for young drivers to prove what they can do.'



This approach changes how Perrin develops every part on the car, ensuring ease of manufacture and reduced costs. 'If you look at the car as an end product first, what will it look like as a real car, not on a CAD screen, then it helps. A car is merely an assembly of components, so to think of a real car you have to think of all of the components, how all the panels fit together, where you put the splits to make them seal properly. With some cars you find that the panel splits are complex with angles and curves. It is really hard to ensure it is properly to make it fit and seal properly, and that costs performance.'

Having worked on the design of three Formula 1 cars, an LMP2, and engineered many others Perrin feels that many designers tend to overlook the usability of some parts. 'A good example of how I design you can see in the LMP car, all the splits are straight,' he explains. 'There is a 30mm return, no joggle and the sealing should be perfect. It makes manufacturing easier too with everything starting on the flat. But you can only do this if you work the way I do, thinking of the end product in detail at the concept stage. Otherwise things like the shape of your chassis won't allow it. A normal LMP with the straight edges would mean your rear brake ducts would have to move. In most design offices the guys who design the bodywork will not even consider where the splits are.'

Indeed Perrin feels that many car designs are overly complex for no real reason, and that some systems seen as essential by many people are actually just areas that can cost more

performance than they deliver.

'In LMP everyone has a quick change rear end where you can change the whole rear end in one – it's really complex to do but some people think it gives an advantage,' Perrin states. 'I ask how many people have ever done a quick change doing the race? I've never seen anyone do it. Actually I have found that doing a quick change rear creates its own issues because of the sealing of that split in the floor, and that creates losses. You ended up taping it to ensure the sealing, but then when you remove the tape it ends up half broken. At one point a lot of cars were breaking their legality panels in races, but the extra stop to change it was so punishing they just made the panels stronger.'

Quick change

Perrin also believes that this tendency to over-complicate things also applies to some mechanical components. 'I remember an extreme case, an old Reynard, where everything was made to be quick change, I think the 2KQ. The gearbox was not part of the car, the rear suspension was on the bell housing, so the bell housing was massive. It went over the gearbox just so that they could change the gearbox quickly. You can imagine how heavy that was,

and the stiffness was really bad, and it hit performance. Even at the top level, a racing car should be as simple as possible, like a kart. But doing it my way you can't afford to spend the time on these kind of solutions anyway. You just spend time doing the things that matter, lightweight components and simple mechanical systems.'

The first product of this new approach is the Perrin LMP1, a Judd-powered hybrid with twin energy recovery systems. While the car has only been built to a mock up stage the design is fully complete and the car is ready for manufacture. Currently the company is looking for around £2 million in order to build and run the first chassis in 2015. However while the hunt for funding continues a new project had started, the Perrin grand prix car.

'This is not an official Formula 1 car,' admits the designer. 'Instead it is a car fully designed to the Formula 1 technical regulations. We are not a Formula 1 entrant and we have no intention of being one. It means we have a lot of potential. We could be an engine manufacturer or technology testbed. Young drivers could use our car to get a super licence or to get up to speed with modern F1. Ultimately though I want the design to be racing, either a manufacturer

“This is not an official Formula 1 car. Instead it is a car fully designed to F1 regulations. We are not an F1 entrant and have no intention of being one”

Perrinn F1 by design: typical of the generic parameters of the project, the power unit installation not yet been done

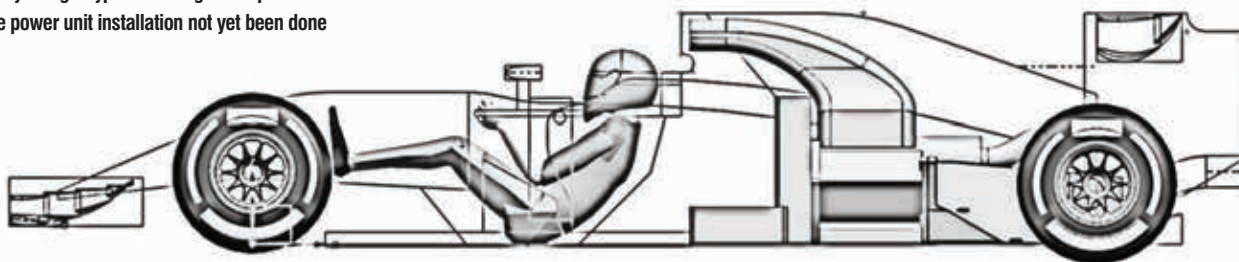

'What all these drivers want is a shot in a F1 car, but unless they pay huge money to do a young driver test (and not all teams sell the seats) there is no way to prove what they can do it'

adopts the design or a group comes along and sees what we have got and decides to race it,' Perrin admits.

The design is based on the 2016 Formula 1 technical regulations and uses the same design philosophy as the LMP1 car, but now fully developed. While the 2016 rule book is not published, in draft form at least it largely carries over from the 2015 rules. But in the current financial climate in Formula 1, developing an all-new project like this seems unlikely from a business point of view, especially for a start-up like Perrinn.

'Actually for a company like this Formula 1 is better commercially than LMP1,' says Perrin. 'Firstly, there is more money in F1 than there is in WEC, and the teams are so much more restricted with what they can do with their cars. We can do what they cannot do.'

'How many young drivers are there out there with a budget trying to get into F1? Many came to me when we announced the LMP car and I realised from speaking with them what they

really wanted was an F1 car. For them, LMP1 is something to do after F1. They see it as a retirement fund. What all these drivers want is a shot in a F1 car, but unless they pay huge money to do a young driver test (and not all teams sell the seats) there is no way to prove what they can do. There is no car that is close enough to an F1 car that lets them show it. Not just in terms of lap time because cars like Super Formula and GP2 are not that far off, but also in terms of sensitivity and the way it handles.

'Also you can't get a super licence with a GP2 car, and from a publicity and marketing point of view, a GP2 car does not look like a Formula 1 car. Even if they do not use it for a super licence it's still important for a driver. Yes, they can go on the simulator and that's valuable. It's only good up to a point, this is the next stage. With this car a driver could be fully ready for F1.'

The design of the car is in the very early stages, with Perrin currently working through the main components and overall car architecture, but the design is advancing

quickly. At this stage the power unit of the car is not finalised and indeed with a choice of four suppliers currently, and the possibility of a rule change in 2016 Perrin is keeping the design flexible.

'We could use an older V8 engine, if we could not get a V6 turbo,' he admits, but insists that the main aim is to build a fully compliant 2016 car. However, with the suppliers keeping data very close to their chests it would on first impression seem like a difficult challenge to design an adequate installation for the 2015/2016 specification units, even if the rules stay the same. 'I think the installation of these power units is not as complicated as some people make out, putting an engine in a car. It's all about making sure it cools properly and that vibrations are handled,' Perrin contests. 'Yes it is a Formula 1 car, so it's a bit more sensitive in some areas, but for me it's no different to putting an engine in an LMP1 car. We need the information to do it of course. But I can say that we already have some ballpark figures.'

'But overall we will have to design the car without the final numbers for the power unit, but we will be within 10-15 per cent plus or minus in terms of cooling. That was the same case for the cars that turned up in winter testing last year though.'

Customer solution

In terms of the car's transmission Perrin will almost certainly adopt a customer solution, Ferrari and Red Bull both offer off the shelf units, though that does not give much freedom in terms of rear suspension layout. But he feels that a long trusted supplier is the best bet. 'We want to use an off the shelf Xtrac system in both LMP1 and F1,' he reveals. 'For the LMP we already have it integrated into the design and for F1 we can do the same.'

In terms of manufacturing the car in time for winter testing in 2016, Perrin plans to outsource all of the manufacturing to mainly UK based suppliers. 'I would rather build a network of companies which all have some shares in Perrinn,' he says. 'They will build the parts and we will do the assembly here in the Yorkshire Dales, I think it's important to assemble the car so you can see how it all comes together.'

Perrin intends to give the supplier a fully optimised and ready to produce set of drawings, with the only major exception being the

“Overall we will have to design the car without the final numbers for the power unit, but we will be within 10-15 per cent in terms of cooling”

Perrinn's 2015 LMP1 offering for Le Mans. Says Perrin, 'It is important to have one person in charge of the whole thing. The whole car is in his head'

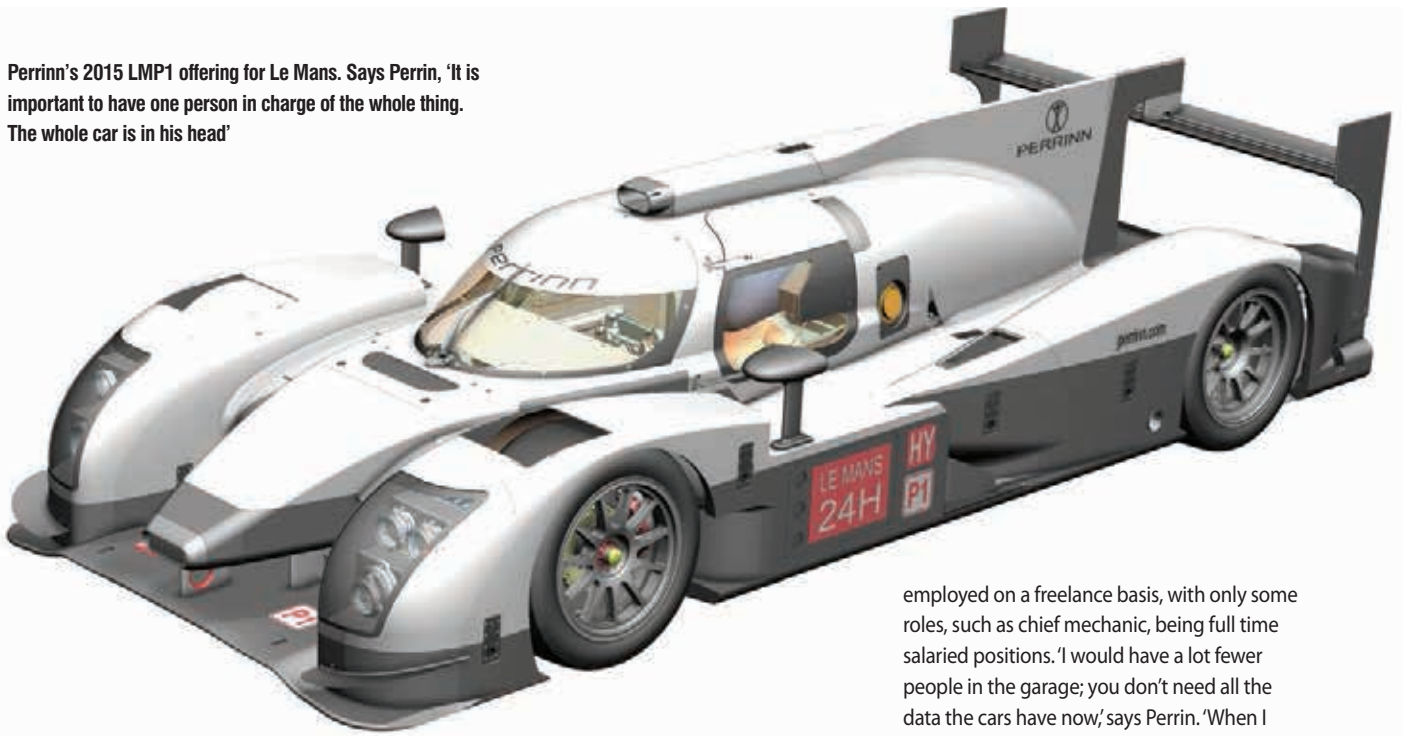

composites, although extensive work will be done in this area. 'I calculate the thickness of both the honeycomb and the skins. This gives the total thickness of the monocoque so the inserts can be accurately designed early on. This also allows for detail design of the composites too. Everything has to be done properly, that is my philosophy. When we do the F1 crash test we need to have an FIA delegate there. We would not run the car if it was not homologated. But to homologate it and have the FIA sign the papers is the same as LMP1 really in terms of process and cost.'

The current situation with F1 costs is something that Perrin is apparently enthused by. Indeed, he thinks it makes his design method even more relevant. 'There is lots of talk now about the model of F1 financing and how it works and my answer is simply to use the regulations as they are, stop trying to fight the regulations. It's tiring, meeting after meeting. It was the same at Le Mans, trying to change the rules. But in F1, take the regulations as they are and be a bit clever and spend less, to make sure your business does not fail. In fact, the best thing about Formula 1 is that the teams know exactly how much they can guarantee that they will pocket every season from FOM. That's a nice place to be, it's better than it is in WEC where they don't give you any money. So, if tomorrow someone said they have to put together an F1 team, I already know what my budget is, and I could do something really good. You know we could do it for £35m, take a margin, and spend 75 per cent as the team budget. But don't expect a factory with 400 people. You will perhaps only have 40-50 people. If you employ 300 people to start with, that would kill the budget. It is all proportional to how many people you employ. If you have 200-300 people you have to keep them busy doing the R&D

work and the development parts. You could do F1 for £25-35m if you kept very few people.'

Huge budgets

Perrin feels that the culture of some F1 teams is a major factor in the huge budgets they are spending, and he also feels much of the money is squandered. 'The so-called development race in F1 makes me laugh,' he says. 'It is the reason some teams cannot meet their budgets; they spend so much money racing themselves, not the others, just to get new bits out. I don't think it makes sense for a small team in F1 to come up with ten upgrades a year or more. Up to Barcelona of course it is worth it because you can see up 0.5 seconds a lap gain, but after that they often do not see any gains. They are just keeping the engineers busy and pushing parts out to justify the investment. Sometimes the updates appear on the track just to show the investors what it is they are paying for. Is this new £50,000 front wing worth it? Sometimes they do not even show a gain on track.'

If Perrin were to field a grand prix team, which he emphasises is not the plan, he would use his design approach to cut costs. 'I would suggest that you do one car a year with a Monza and Spa kit, and then move on, and not mess around always trying to bring something new. You can start much earlier this way. Rather than worry about the development race you focus on the new car. You could halve the budget.'

That philosophy would carry across to the team as a whole. Most of the staff would be

employed on a freelance basis, with only some roles, such as chief mechanic, being full time salaried positions. 'I would have a lot fewer people in the garage; you don't need all the data the cars have now,' says Perrin. 'When I started, I wanted all the data I could get because I wanted an insight and an understanding of everything. I wanted a fully strain gauged suspension, all the loads, everything. There are so many sensors, and getting them all to work properly is tough. It's 15-20 channels per corner. Then you do a huge amount of work to reduce the data to the contact patch loads per corner. Then you look at the results, compare it with lap time simulation data, and other data and realise it's all the same. If you do the simulation right you don't need all the sensors. With experience you realise you don't need it or all the people to do it.'

Of course, for a company like Perrinn it seems illogical to come into being and then to immediately design cars for two of the top international motorsport classes, both of which are limited in terms of actual entrants, but Perrin believes that the seemingly more logical, F3, F4, LMP2 and the new LMP3 markets are actually a tougher area to operate in. 'I only want to do F1 and LMP1 as a company. I ask this question, who do you know who can deliver an F1 or LMP1 car these days? There are not many and that's why we have a big chance. The LMP2, LMP3 and F4 markets are really crowded. Why should I spend time at a lower category when we can be strong at the top categories?'

Perrin is looking for investment of around £2 million, which would see the LMP1 car built and tested. That process would also advance the development of the F1 car. If that happens, then what you see here could be a very interesting new car constructor coming into existence. 

“If tomorrow someone said they have to put together an F1 team, I already know what my budget is, and I could do something really good”



The next step?

In 2014 F1 welcomed, if reluctantly, hybrid power unit thinking and shed its anachronistic tag, but what in this cost-conscious world, what's next?

By SAM COLLINS

The introduction of advanced hybrid technology into Formula 1 has not been a smooth process. When McLaren first tried to use a modest hydraulic energy recovery system in 1998 the concept was quickly banned for fear that it would give the team an unfair advantage. Energy recovery systems would not reappear until just over a decade later in 2009 with teams able to run 60kW units, which today look weighty, cumbersome and deliver rather mild performance. But most competitors struggled to get them to work properly and the costs of developing the technology were felt to be excessive. The teams agreed not to use hybrid systems in 2010. In 2011 they reappeared, but failures were still common and the uptake was not universal until 2013. Throughout this period it became very apparent that Formula 1 was seen as a technical anachronism, using very old fashioned port injection V8 engines which were fixed in specification mated to the very mild hybrid system.

The new power unit rules introduced in 2014 took the technology to the next step, as regulations followed the automotive industry trends of increasing efficiency, downsizing the engines' capacity while increasing the potency

of the hybrid systems. Formula 1 was becoming road relevant and the new rules attracted one new manufacturer, Honda, and almost a second, namely Volkswagen.

Despite much fanfare and excitement from the manufacturers, almost as soon as the new power units hit the track there was a backlash against them. Initially it was led by the mainstream media which struggled to understand and explain the technology, instead opting to write articles criticising the sound of the cars or to ignore the new technology all together.

During the season the backlash became more serious with Bernie Ecclestone taking many opportunities to criticise the noise of the cars. Then, as it became clear that Mercedes had done a much better job on developing its power unit than its rivals then some teams including Red Bull and Ferrari joined in.

When asked at the US Grand Prix about the ongoing crisis surrounding the financial viability of the smaller grand prix teams Ecclestone went out of his way to hit out at the rulebook.

'We need to change the regulations, we have to get rid of these engines, they don't do anything for anyone, they are not Formula 1 and we are going to try to get something changed in

the off season,' he complained. Ecclestone later went further in a BBC interview and seemingly suggested that a single-make engine could be used in future; 'It is often thought that having a one-make formula like GP2 is a good idea. We built Formula 1 on a one-make engine, apart from Ferrari, and that was the Cosworth DFV.'

It was clear that the power unit rules were, and indeed still are, under discussion. But after initial suggestions were that a return to the old V8 engines could have been on the cards it was quickly pointed out that any major change would be unrealistic for this season.

While no formal proposition has been made for 2016, some details of what has been put on the table have been revealed. 'An awful lot can be done for 2016 and maybe we need to even go as far as looking at a different engine. Maybe still a V6 but maybe a more simplified V6 that controls the cost', explained Red Bull team boss Christian Horner. 'The scenario at the moment is such that it's unsustainable, it's unsustainable for manufacturers, any of the manufacturers, to keep spending at the level that they are, and therefore, rather than perhaps going backwards with the V8, maybe we should potentially keep the basis of what has been achieved but look at simplifying it.'

Regulations followed the industry trends of increasing efficiency, downsizing the engines' capacity while increasing the potency

The cost of racing of Formula 1 has been widely documented and it is clear that a number of teams lay this at the feet of the engineers behind the new rules.

'These regulations were given to engineers, but unfortunately when a bunch of engine engineers are left on their own to come up with a set of regulations, they come up with something tremendously complicated and tremendously expensive,' Horner complains. 'The engines that we have today are incredible bits of machinery, incredible bits of engineering, but the cost to the collective manufacturers has probably been close to a billion euros in developing these engines, and then the burden of costs has been passed on, unfortunately, to the customer teams.' Mercedes claims that it spend around £100m on the development of its 2014 power unit.

With the basic architecture of the current 1.6-litre V6 internal combustion engine seemingly at the core of all of the serious proposals it is the ancillary components that may be changed.

'I think we have to recognise what has been done from an engineering point of view and now look to simplify things, potentially retaining the V6 philosophy but perhaps going to a twin turbo that would address the sound issues that we've had this year,' Horner continues. 'We've had a standard ECU, why not potentially take it a step further. A standard energy recovery system would dramatically reduce the costs, dramatically reduce development and therefore the supply price to the customer teams also.'

Switching to a twin turbo layout would significantly change the layout of the rear of a 2016 car, especially in terms of packaging and cooling. More significantly it also suggests that Horner favours dropping the exhaust gas energy recovery system from the power unit as an adoption of twin turbo would also require twin MGU-Hs.

Indeed some, like Bernie Ecclestone, are in favour of dropping the turbocharger altogether in an attempt to get a more fan-friendly sound from the cars. 'I have been proposing and am going to propose that we go back to a normally aspirated engine with some hybrid bits built into it,' Ecclestone admits. 'The manufacturers will have to call it a McLaren hybrid, Ferrari hybrid or a Williams hybrid so that it will get the message across. It would be a bit of a dream for them to build a normally aspirated engine and then develop it to about 1,000 horsepower which is what I believe we want.'

This is something not all that far removed from what both Porsche and Audi are doing in the World Endurance Championship. But in that series the manufacturers are largely free to develop the power units – something that is restricted in application for reasons of reliability, cost and safety in Formula 1. With the dominance of Mercedes, both Renault and

Twin turbo V6s, as raced in the US, lie at the heart of a series of change proposals in F1 power units



especially Ferrari want more freedom to work on their designs in season. 'We need to look at something different in 2016. In terms of power unit and in terms of regulation,' former Ferrari boss Marco Mattiacci said. 'For 2015 it is clear we will have to accept the status quo for now but we are definitely not going to accept the status quo for 2016. The cost of the power unit is a problem and the fact that we cannot enhance our power unit during the season is a cost for us.'

The introduction of the new generation power units has had a mixed response and many feel that it will be impossible for Renault and Ferrari to catch up with the dominant

continue to surround the arrival of other new manufacturers. A majority vote is required to change the regulations, and that would have to happen by March this year.

Mercedes, which has a dominant position in the sport and controls the votes of at least two teams in F1, is openly against any change.

'The current format of power units was actually proposed by Renault back then and for us, as Mercedes, it's a hugely important showcase of technology, road-relevant technology, hybrid technology, the future. It helps us to attract sponsorship and for us, as a car manufacturer – and I guess the same

“The engines we have today are incredible bits of engineering, but the cost has probably been close to a billion euros in development terms”

Mercedes PU106A hybrid design. And it remains that many feel that the new units are just far too expensive.

'We will not attract new manufacturers into the sport and we may well drive current manufacturers out of the sport,' Horner adds. 'So we have to think, not just about today but about the future. For 2015, there's very little that can be done with the regulations but for 2016, an awful lot can be done and I think that the teams, together with the FIA and the promoter, have to have that responsibility to ensure that those issues are addressed and the sport is sustainable and attractive to new manufacturers to come in.'

Ferrari and Mercedes have committed to staying in Formula 1 until 2020, Honda has claimed that it 'will never leave F1' and rumours

was the case for Renault when they came up with the idea – that is very important. It's less important for Red Bull, for sure, but for us it's crucial,' Toto Wolff, Mercedes Motorsport boss argues. 'Reversing everything, changing the format, changing the engines would just increase costs, it would be the opposite for what we need for Formula 1 at the current stage.'

'We are all talking about costs and if you would open up the regulations in the way it has been described, that clearly means you don't care about costs because that would be like digging a grave for F1.'

However it does seem likely that some kind of compromise will be reached over the power unit regulations for 2016. How far that compromise will go remains to be seen. 

THE PERFECT CHRISTMAS GIFT

SUBSCRIBE FOR FAMILY AND FRIENDS

Give the gift that lasts all year!



LUXURY PRINT EDITION
FROM ONLY
£44.95
PER YEAR

SAVE
OVER
£26

Plus Receive a FREE gift card to send to your friend



ALSO AVAILABLE IN DIGITAL FORMAT

- Download to your computer, smartphone or tablet device
- Instant delivery worldwide
- Easy access anywhere, anytime!

ONLY £34.95 FOR 12 ISSUES!

 www.chelseamagazines.com/racecar-RX5P for print
 www.chelseamagazines.com/racecar-RX5PD for digital
 +44 (0)1795 419 837 quote RX5P for print or RX5PD for digital